

# International Window Standards

FINAL REPORT | APRIL 2014



Prepared for



Homeowner  
Protection Office  
Branch of BC Housing

by



# Acknowledgements

## Funding Partners

This project was completed with the support of the following funding partners:

- Natural Resources Canada (NRCan)
- Homeowner Protection Office (HPO), branch of BC Housing
- Fenestration Canada
- Window and Door Manufacturers Association of BC (WDMA-BC)
- Glazing Contractors Association of BC (GCABC)
- Canadian Glass Association (CGA)
- Association des industries de produits de vitrerie et de fenestration du Québec (AIPVFQ)
- BC Hydro
- Manitoba Hydro
- Hydro-Québec

## Steering Committee and Technical Review

The following steering committee members provided technical direction and review for the project:

- Al Jaugelis, Fenestration Association of BC (formerly WDMA-BC)
- André Laperrière, Hydro-Québec
- Anil Parekh, Natural Resources Canada (NRCan)
- Catherine Lemieux, GCABC
- David Bruce, BC Ministry of Energy, Mines and Natural Gas
- Gary Hamer, BC Hydro
- Gilbert Riopel, AIPVFQ
- Harry Schroeder, Manitoba Hydro
- Jean-Francois Kogovsek, AIPVFQ
- Jean Marois, Fenestration Canada
- Jeff Baker, Fenestration Canada
- John Nicol, BC Ministry of Energy, Mines and Natural Gas
- Leonard Pinalto, CGA
- Lisa Bergeron, Fenestration Canada
- Morgan Hanam, Enermodal Engineering Ltd.
- Normand Bigras, Hydro-Québec
- Steve Hopwood, Natural Resources Canada (NRCan)
- Terry Adamson, WDMA-BC
- Voytek Gretka, BC Ministry of Energy, Mines and Natural Gas

## Executive Summary

With the growing interest in the Passive House standard for energy efficient buildings, European fenestration products are being used more frequently in North American jurisdictions. This has created challenges for building designers and product manufacturers as the differences between North American, European ISO and Passive House thermal performance rating systems for windows have led to misunderstandings about the appropriate criteria for energy efficient product selection. The same window will have different U-value and solar heat gain ratings under each of these systems, and there is no straightforward way to compare North American and European product performance.

This study was undertaken to better understand the ISO and Passive House fenestration energy rating systems by comparing them with the NFRC/CSA rating system used in North America. In addition to identifying the conceptual differences between them, this study uses computer simulation methods to illustrate how these differences can result in significantly different product ratings.

A literature review of the key standards related to the calculation of window U-values and solar heat gain in North America and in Europe was performed. There are many differences in standard conditions and calculation methodologies between the standards, some of the primary differences include the following:

- Different boundary conditions used for simulations, including indoor and outdoor temperatures, surface film coefficients, and incident solar radiation.
- Differences in the properties that are measured: NFRC/CSA rating procedures were designed to compare the relative energy performance of glazed fenestration products under identical size and environmental conditions, and formally report only whole product values for U-value, Solar Heat Gain Coefficient (SHGC), and Visible Transmittance (VT) at specified standard sizes. They do not provide values that can easily be extended to products at other sizes or configurations (though frame, edge and centre of glass values are used in the whole product calculation). In contrast, ISO rating procedures were developed to compare framing systems, spacers, and glass products independently of one another, under different environmental conditions. These three properties can be used in area weighted calculations to determine window U-values for actual sizes, which can be used in whole building energy modeling.
- Different methods used to determine thermal performance properties: NFRC/CSA methods evaluate complete products and generate separate ratings for every combination of frame, spacer, and glass options offered by a manufacturer. ISO methods evaluate frame U-value using a calibration panel of specified conductivity in place of the actual glazing and spacer, then determine an edge-of-glass linear transmittance value ( $\Psi$ ) obtained by modeling the actual frame and spacer and subtracting these from the transmittance modeled with a calibration panel. Centre of glass U-values are also computed differently. While NFRC/CSA uses a comprehensive algorithm to evaluate thermal transmittance across the gas gap, ISO uses a simplified procedure that yields different results.
- Different reference sizes for reporting whole product performance: NFRC/CSA sizes vary for each window and door operator type. Passive House products are compared using a single reference size for comparing the performance of windows and another for doors, but requires actual project window sizes to be used for whole building energy modeling.
- Differences in treatment of sloped glazing: NFRC/CSA simulates skylights and other sloped glazing at an angle of 20° above the horizontal. Following ISO standards, skylights are simulated in a vertical position for comparing products, while Passive House certification simulations require roof windows (skylights) to be modeled at a 45° inclination.
- Installed window energy performance: NFRC/CSA methods evaluate the product only. Passive House criteria for windows include both a maximum U-value for the product at the reference size, and a maximum U-value for the installed product that includes the interface with the wall. The thermal transmittance of the window-wall interface is reported as a linear thermal transmittance value (also denoted as  $\Psi$ ), and this value is used with actual project window sizes for whole building energy modeling.

To quantify the difference in U-value and solar heat gain under the different standards, three window products were simulated to determine their characteristics following both NFRC/CSA and ISO rating methods. Two were North American windows, one with a vinyl frame and one with a fiberglass frame. The third was a German vinyl window system capable of Passive House certification with appropriate glass. All were simulated using high performance North American insulating glass units.

The simulations illustrate significant differences in the whole product U-values under NFRC/CSA and ISO methods. While there are many differences between the ISO and NFRC/CSA calculation methods, one of the main factors that impacts U-value differences is the difference in thermal transmittance through the gas gap of the insulating glass unit (IGU) arising from the use of different simulation algorithms and different boundary conditions. As a result, European windows are optimized for larger gas gaps that yield the lowest U-values under ISO methods. Products optimized for NFRC/CSA winter conditions yield the lowest U-values with significantly narrower gaps.

Differences in the evaluation of solar heat gain through glass are less significant, but are still present. While both ISO and NFRC/CSA methods can calculate both centre of glass and whole window values, it is important to note that the NFRC/CSA Solar Heat Gain Coefficient (SHGC) reports the whole window value whereas ISO/PHI g-values typically report centre of glass values which are required for the Passive House Planning Package (PHPP) software.

While the study found that there are no correlations that would allow for direct conversions between different NFRC/CSA, ISO, and Passive House thermal performance ratings, several important considerations can be drawn for designers, specifiers, and manufacturers:

- Passive House building energy modeling tools require center of glass solar heat gain “g-values,” whereas the NFRC/CSA Solar Heat Gain Coefficient (SHGC) is a whole window value. This study shows that whole window solar heat gain values can be up to 50% lower than centre of glass values. NFRC/CSA simulations can provide center of glass solar heat gain values that are similar, but not identical to ISO g-values.
- It is important when performing whole building energy modeling to input the correct NFRC/CSA, ISO or PHI U-value and SHGC/g-value into the model, and when comparing windows to use values determined according to a common standard. This is particularly important for Passive House PHPP software, which is intended to be used with ISO or PHI inputs. While most North American whole building energy modeling programs do not specify which standard is to be used for U-value inputs, NFRC/CSA U-values are assumed. ASHRAE 90.1 requires NFRC values to be used. Most European and North American window manufacturers do not have both NFRC/CSA and ISO certifications, which can complicate this issue.
- Passive House windows certified through PHI have their U-values determined at various different winter temperatures. The exterior temperature used to determine centre of glass U-value is climate-specific, while the exterior temperature for frame U-value simulations is -10°C. This means windows certified through PHI may have been modeled under different conditions compared to other PHI-certified windows (since different climate zones have different boundary conditions).
- In addition to the Passive House Institute window certification program, there is an additional related program in use in Germany, created by the Rosenheim Institute. While both the PHI and the Rosenheim programs require products to achieve the same whole product and installed product performance criteria, their different evaluation methods allow products with higher frame U-values to achieve certification under the Rosenheim program.
- NFRC simulation tools can be used to determine the ISO U-values and centre of glass g-values for NFRC-rated products using existing THERM and WINDOW simulation files. These tools can be used to optimize window designs to achieve Passive House performance levels.
- Finally, it should be recognized that each of the window thermal performance rating programs (NFRC/CSA, ISO and Passive House) have strengths and weaknesses, and not one of them may be optimal for selecting windows for a particular building. NFRC/CSA U-values are modeled at an outdoor temperature of -18°C, which is not representative of average winter temperatures in many North American locations, and is also colder than the winter design temperature in many locations. It is therefore less accurate for annual energy modeling or for optimal design in many locations. It is however more appropriate for peak design and equipment sizing calculations as it provides a worst case temperature for many locations. The ISO outdoor temperature of 0°C and the Passive House climate-specific outdoor temperatures will be more accurate for annual energy calculations but less accurate for peak heating and equipment sizing calculations in many locations. Designers should recognize that while consistent conditions are needed for rating and comparing products, the certified U-values from a particular rating system may not lead to optimal window selection for a particular climate. Additional research work should be undertaken in this area.

## Table of Contents

1. Introduction.....	1
2. Literature Review .....	2
2.1. North American Standards .....	2
2.2. ISO Standards.....	3
2.3. Passive House Standards .....	5
2.4. Comparison of Standards.....	7
2.5. Window Inputs to Whole Building Energy Modeling Programs .....	11
3. NFRC/CSA, CEN and PHI U-value Calculations .....	12
3.1. Windows Simulated .....	12
3.2. Methodology.....	13
3.3. Window 1 – North American Vinyl Frame .....	13
3.4. Window 2 – North American Fiberglass Frame.....	20
3.5. Window 3 – European Vinyl Frame .....	26
3.6. Relationship between NFRC/CSA and ISO U-values .....	33
3.7. Summary.....	35
4. Conclusions.....	37
4.1. Primary Differences Between Standards .....	37
4.2. Impact on Thermal Performance Values .....	39
4.3. Considerations for Designers and Specifiers....	39
4.4. Considerations for Manufacturers and Product Design.....	40
4.5. Future Work.....	41

# 1. Introduction

The purpose of this study is to compare North American and European fenestration energy performance standards, including those used to qualify windows for buildings designed to Passive House standards. Differences between window ratings systems can create difficulties in qualifying North American fenestration products for Passive House buildings, and in qualifying European Passive House products for use in North American jurisdictions. This study seeks to identify and quantify differences between the rating systems.

Section 2 summarizes a literature review of the key standards related to the calculation of window U-values and solar heat gain in North America and in Europe and identifies the primary differences between them.

Section 3 presents the results of thermal simulations for three window framing systems, two of North American design and one German Passive House window system, comparing the overall U-value and Solar Heat Gain Coefficients determined according to NFRC/CSA and ISO criteria. The results show the difference in how these standards evaluate the centre of glass, edge of glass, frame and whole product U-values, as well as the centre of glass and whole product solar heat gain.

Section 4 provides a summary and conclusions from this study. The conclusions will help designers and manufacturers to recognize the differences between window rating systems in North America, Europe, and for Passive House.

## 2. Literature Review

This section summarizes the literature review of key North American, European and Passive House standards related to fenestration thermal performance. Appendix A provides a list of references and a summary sheet for each reference that was reviewed in detail; the summary sheets contain further information on each reference.

### 2.1. North American Standards

The primary organization for rating the thermal performance of windows in North America is the National Fenestration Rating Council (NFRC). NFRC is a non-profit organization created to provide independent verification of fenestration product energy performance. NFRC administers two programs to ensure that the energy performance ratings found on NFRC labels are fair, uniform, and credible:

- The Product Certification Program (PCP) designed for residential fenestration products, which evaluates products under standard environmental conditions and at standard sizes. Only single-lite configurations are rated, and multiple-lite products together with intermediate framing members are ignored in most cases.
- The Component Modeling Approach (CMA) program for non-residential products, which can evaluate products of both standard and non-standard size. CMA uses the same frame and glass simulation methods as the PCP program, but uses a simplified linear spacer value that allows for area weighted calculations using frame, glass and spacer values from the CMA database.

NFRC simulations do not go beyond the visible edges of the installed fenestration product to include the window-wall interface. In the case of products recessed into floors or walls, the simulation ends at the visible edges of the product and do not include the embedment effects.

The NFRC publishes several standards related to the testing or rating of window thermal performance, including thermal performance simulation standards *NFRC 100 Procedure for Determining Fenestration Product U-factors* (NFRC, 2010), and *NFRC 200 Procedure for Determining Fenestration Product Solar Heat Gain Coefficient and Visible Transmittance at Normal Incidence* (NFRC, 2010). Other standards published by the NFRC include laboratory testing standards for U-value and SHGC, procedures for determining condensation resistance, and others.

In Canada, *CSA A440.2-09 Fenestration energy performance* (CSA, 2009) specifies thermal performance requirements for windows. This document references NFRC 100 and NFRC 200 for the computer simulation of U-value and SHGC, respectively. CSA A440.2 also includes the Energy Rating (ER), described in detail in the report *Review of Window Energy Rating Procedure in Canada* (RDH, 2012).

NFRC 100 provides a method for determining the U-value (or U-factor) of fenestration products by computer simulation. This simulation method is one of two options in the standard ISO 15099. NFRC 100 also provides boundary conditions (indoor and outdoor temperature, wind speed, and surface film coefficients) to be used in the modeling, as well as standard sizes for different types of fenestration products. The standard surfaces temperatures are 21°C interior and -18°C exterior. Skylights and other sloped glazing products are simulated at an angle of 20° above the horizontal, while all other products are simulated in the vertical position<sup>1</sup>. Three component U-values are determined:  $U_{\text{frame}}$ ,  $U_{\text{edge}}$ , and  $U_{\text{glass}}$ . These values are area-weighted to determine the overall product U-value using the standard sizes. The CMA also lists effective thermal conductivity,  $K_{\text{eff}}$ , of spacers. However, the CMA calculates overall product performance using “best” and “worst” simulations and interpolating curves.

NFRC 200 provides a method for determining the SHGC and VT of fenestration products by computer simulation. The method gives different boundary conditions from NFRC 100 for determining the centre of glass SHGC. However the same standard

---

<sup>1</sup> Sloping of an IGU from vertical has a significant reduction in thermal performance due to increased convective heat transfer between the panes of glass and is therefore an important factor to consider in true thermal performance of a skylight.

fenestration product sizes are used as in NFRC 100. The NFRC 200 SHGC is calculated for the whole product including both glazing and frame areas. NFRC 200 indicates that its methods are in accordance with ISO 15099 except where noted (see Section 2.4).

NFRC 100 and 200 require the use of approved simulation programs for the computer simulation of U-value and SHGC. The NFRC approved software list for these two standards includes THERM version 6.3 for two-dimensional heat transfer simulation, and WINDOW version 6.3 for simulating glazing units (centre of glass) and whole product calculations. These programs implement one of the two methods identified in ISO 15099, the area weighting method. Another important document in completing NFRC 100 and 200 simulations is the NFRC Simulation Manual (LBNL, 2003). This manual specifies how to use the THERM and WINDOW programs to model products for NFRC/CSA certification.

## 2.2. ISO Standards

In contrast to the NFRC/CSA focus on rating and comparing fenestration products, the ISO standards were developed to allow the energy performance of any fenestration product size or configuration to be determined under a standard set of environmental conditions. While they can be used to compare the performance of competing products, they are more commonly used to estimate the energy performance fenestration product configurations contemplated for a particular building.

Like the NFRC/CSA standards, the ISO standards do not go beyond the edges of the fenestration product to include the anchoring system.

There are several European standards related to the thermal performance of windows. The primary documents reviewed here include:

- *ISO 10077-1 Thermal performance of windows, doors and shutters – Calculation of thermal transmittance – Part 1: General*
- *ISO 10077-2 Thermal performance of windows, doors and shutters – Calculation of thermal transmittance – Part 2: Numerical method for frames*
- *ISO 15099 Thermal performance of windows, doors and shading devices – Detailed calculations*
  - Calculation procedure for U-value, g-value, and visible light transmittance
- *EN 673 Glass in building – Determination of thermal transmittance (U value) – Calculation method*
  - Calculation method for centre of glass U-value
- *ISO 10292 Glass in building – Calculation of steady-state U values (thermal transmittance) of multiple glazing*
  - Calculation method for centre of glass U-value
- *ISO 18292 Energy performance of fenestration systems for residential buildings – Calculation procedure*
  - Calculation procedure for an Energy Rating similar to CSA A440.2
- *EN 410 Glass in building – Determination of luminous and solar characteristics of glazing*
  - Calculation procedure for solar characteristics of glazing
- *BR 443 Conventions for U-value calculations*
  - British conventions for calculating U-values of building enclosure components including vertical and sloped glazing, including reference sizes

ISO 10077-1 and 10077-2 give a calculation method to determine the thermal transmittance (U-value) of windows and doors. This standard has two parts: the first presents the overall product calculation, and the second specifies the calculation of thermal transmittance of frame profiles (for use in the first part). This calculation incorporates the centre of glass U-value ( $U_g$ ), the frame U-value ( $U_f$ ), and the linear thermal transmittance due to the combined thermal effects of the glazing, spacer and frame ( $\Psi_g$ , i.e.



the edge of glazing effects). The thermal transmittance of each of these components refers to other standards: glazing references EN 673, opaque panels references ISO 10211, and the frame and edge components reference ISO 10077-2. ISO 10077-1 gives standard surface resistances, but does not provide other boundary conditions (including surface temperatures).

Following ISO 10077-2 (Part 2), the thermal transmittance of a frame section is calculated using a two-dimensional numerical methods program, simulated with the glazing replaced by an insulating panel with thermal conductivity  $k = 0.035 \text{ W/m-K}$  and thickness to match the IGU it replaces. The linear thermal transmittance of the interaction of frame and glazing (edge effects) is determined both with the glazing in place and with the glazing replaced by an insulated panel. The standard gives surface resistances as well as temperature conditions at which the calculations are to be performed; the interior temperature is to be  $20^\circ\text{C}$ , and the exterior temperature  $0^\circ\text{C}$ .

ISO 15099 describes a procedure for calculating the total fenestration product thermal transmittance, total solar energy transmittance, and visible light transmittance (intended for use in a computer program). There are two options for calculating the U-value of a fenestration product: a centre of glass, edge of glass and frame U-value area weighted calculation (which is the NFRC/CSA method), or a centre of glass and frame U-value plus edge of glass linear transmittance ( $\Psi$ ) method as in ISO 10077. This standard references ISO 10077-2 for frame and edge thermal transmittance and linear transmittance values. ISO 15099 also gives a calculation for the total solar energy transmittance of a product, which is area-weighted from the glass and frame solar energy transmittance values.

ISO 10077 and 15099 are two independent standards that specify different methods for calculating U-value. ISO 10077 specifies a calculation method for determining U-value only, while ISO 15099 describes a procedure for calculating U-value, total solar energy transmittance, and visible light transmittance. An article by Charlie Curcija, "Discrepancies between ISO window simulation standards" (2005), discusses in greater detail differences between ISO 10077 and ISO 15099. The article identifies limitations of ISO 10077 including its simplified methods and reference to conflicting standards. The article also shows differences in centre of glass U-value simulation results for several IGUs following the two ISO standards. ISO 10077-1 also identifies that it contains less accurate algorithms than those in 15099: "NOTE The correlations for high aspect ratio cavities used in EN 673 and ISO 10292 tend to give low values for the equivalent thermal conductivity. More accurate correlations are given in ISO 15099."

Standard EN 673 is referenced by ISO 10077-1 for determining the thermal transmittance of the glazing unit (the centre of glass U-value). EN 673 does not cover edge effects or solar heat gain. Important information in EN 673 includes standard external ( $h_e$ ) and internal ( $h_i$ ) surface film coefficients to use for the purpose of comparing glazing U-value:  $h_e = 25 \text{ W/m}^2\text{-K}$  and  $h_i = 7.7 \text{ W/m}^2\text{-K}$ . EN 673 was originally based on ISO 10292. ISO 10292 also covers rules for calculating thermal transmittance in the glazing central area (centre of glass U-value). This standard is similar to EN 673. The surface film coefficients in ISO 10292 are slightly different from EN 673:  $h_e = 23 \text{ W/m}^2\text{-K}$  and  $h_i = 8.0 \text{ W/m}^2\text{-K}$ .

The EN 673 calculation of centre of glass U-value is simpler and less accurate than the ISO 15099 algorithms, identified in the excerpt from ISO 10077-1 above. This is described further in the report "TARCOG: Mathematical Models for Calculation of Thermal Performance of Glazing Systems With or Without Shading Devices" (Carli Inc., 2006). The ISO 15099 (NFRC/CSA) calculation is based on a comprehensive heat transfer model, including conductive, convective and radiative heat transfer. A system of energy balance equations is developed, and surface temperatures and heat flux at each layer is solved using numerical methods. The ISO 10077-1 / EN673 algorithms are simplified compared to the ISO 15099 calculations. Properties are evaluated at the mean temperature difference across the gas space; for double glazed systems, this is fixed at a temperature difference of 15 K.

ISO 18292 specifies a procedure for determining energy ratings for window and door products based on thermal transmittance, solar gain and air infiltration. The standard defines a similar rating procedure to the Canadian Energy Rating (ER), where solar gain, air infiltration and transmission (conduction) losses are added to determine an overall rating. The rating can be calculated for both heating and cooling conditions. ISO 18292 references other standards for the calculation of the "total solar energy transmittance or solar factor," the g-value. The g-value can be calculated for a whole fenestration system (frame and glazing)

following ISO 15099, or for glazing only following ISO 9050 and EN 410. Greater detail on this standard is found in the research report for the study *Review of Window Energy Rating Procedure in Canada* (RDH, 2012).

For calculating solar heat gain properties of glazing, standard ISO 15099 references ISO 9050, while standard ISO 18292 references ISO 9050 or EN 410. NFRC 200 references ISO 15099 (which in turn refers to ISO 9050), while Passive House references EN 410. According to information on the LBNL program Window Optics, ISO 9050 and EN 410 are virtually identical.

EN 410 was reviewed as part of this literature search. EN 410 specifies methods for determining the luminous and solar characteristics of glazing in buildings, specifically the Total Solar Energy Transmittance (solar factor), or g-value. This standard defines various other parameters, including the Shading Coefficient (SC), defined as  $SC = g / 0.87$ . This standard references EN 673 for calculating the thermal conductance of multiple glazing layers. Note that EN 410 refers to only the centre of glass solar heat gain for the glazing area, and is not a whole product (glazing and frame) solar heat gain value.

None of these ISO standards provide standard reference sizes to be used for comparing the thermal performance of fenestration products. In the United Kingdom, standard reference sizes are specified in BR 443, which is referenced in the UK Building Code parts L1 (dwellings) and L2 (buildings other than dwellings). BR 443 requires that window U-values be obtained either by measurement (following ISO 12567) or by numerical calculation (following ISO 10077). The standard size for residential windows in BR 443 is 1.23 m wide by 1.48 m high, with a central vertical divider, one opening lite and one fixed lite. For the purpose of comparing products, U-values are calculated for products installed vertically. However for actual building heat loss calculations BR 443 gives a table of conversion factors for determining U-values of sloped glazing (or, the installed angle can be modeled).

### **2.3. Passive House Standards**

The term Passive House commonly refers to the voluntary standard for energy efficient building design developed by Dr. Wolfgang Feist and promoted through the Passive House Institute (PHI) in Darmstadt, Germany. The institute promotes and supports the international Passive House movement through education, through design tools such as the Passive House Planning Package (PHPP), and through certification programs for both buildings and building components, such as windows. The ideals of the passive house movement are promoted by various organizations in different countries, some affiliated with and sanctioned by the PHI, others operating independently of it.

In addition to the voluntary standard of the PHI, passive house principles are being incorporated into European building codes through the European Parliament Building Directive (EPBD) which requires that by December 31, 2020, all new buildings are to be of “near zero energy” construction. While the overall Passive House energy use criteria are incorporated into these building code initiatives, compliance with these building codes does not imply conformance to the requirements of Passive House.

While there is one official voluntary Passive House standard for buildings, there are two fenestration qualification standards for Passive House windows in Germany. The first is the original PHI window certification program. The second, designed to meet the needs of German industry under the EPBC, is defined in ift Rosenheim Directive WA-15/2, *Suitability of windows, exterior doors and curtain walling for Passive Houses*. In addition to these European programs, the Passive House Institute US (PHIUS) launched a Certified Data for Window Performance program in November 2012 that defines Passive House energy performance criteria for North American climate zones.

While it is beyond the scope of this report to review these window certification programs in detail, it is important to recognize that the term “Passive House window” can no longer be assumed to refer to the original PHI window performance criteria. Claims of Passive House qualification need to be evaluated in the context of each particular program as they do not evaluate products under the same conditions. In the simulation component of this study two German Passive House window products from one manufacturer’s product line are evaluated; one optimized for PHI certification, the other optimized for Rosenheim certification.

### 2.3.1 Passive House Institute Window Certification Criteria

The PHI provides two levels of certification: Passive House certified buildings, and Passive House certified components. Certified components are not required to be used in certified buildings, but would help to achieve the building performance targets. Components that may be certified are categorized in the following groups: opaque building envelope (construction and insulation systems, connections), transparent building envelope (doors, glazing, windows), and building services (ventilation systems, heat pump units).

To be certified as a Passive House building, a building must meet several energy criteria including an annual heating demand less than 15 kWh/m<sup>2</sup>, annual cooling demand less than 15 kWh/m<sup>2</sup>, annual primary energy for all end uses less than 120 kWh/m<sup>2</sup>, and air tightness less than 0.6 ACH<sub>50</sub>.

For certified fenestration components, PHI publishes a manual on fenestration certification requirements, *Certification Criteria for Certified Passive House Glazings and Transparent Components*. This document states that U-values and Ψ-values are to be calculated following ISO 10077 and EN 673. In addition to the centre of glass U-value, edge of glass Ψ-value and frame U-value, an installation Ψ-value is calculated; this value is not part of the ISO 10077 standard. The g-value is calculated in accordance with EN 410, and is for the glazing only (not whole product as in NFRC 200).

The Passive House Institute website ([www.passiv.de](http://www.passiv.de)) lists guidelines for enclosure thermal performance to achieve the energy and thermal comfort targets. For fenestration, the overall U-value of all windows (and other transparent building components) should be less than 0.8 W/m<sup>2</sup>-K (0.14 Btu/hr-ft<sup>2</sup>-F) to meet thermal comfort criteria. The Passive House website also recommends windows with “g-values around 50%.” These targets are not required for energy performance. However for component certification, for windows to be Passive House Certified components, the *Certification Criteria for Certified Passive House Glazings and Transparent Components* gives maximum U-values and minimum g-values that vary by climate zone.

The Passive House certification criteria for transparent components also includes several important simulation parameters:

- The standard size window is 1.23 m wide by 1.48 m high
- U-values and Ψ-values for mullions may be reported for information
- Roof windows (skylights) are simulated at a 45° inclination
- Boundary condition temperatures for the simulation of frame components are -10°C exterior and 20°C interior. For the simulation of centre of glass U-values, a different outdoor temperature is taken for each region; 20°C for “very hot,” “hot,” and “warm” regions, 15°C for “warm-temperate,” 5°C for “cool-temperate,” -3°C for “cold,” and -7°C for “arctic.” Note these values are all different than the standard exterior ISO condition of 0°C. However, the Passive House criteria also state that for the cool-temperate region, EN 673 values are also acceptable (ISO, 0°C exterior). This means that PHI simulations for the cool-temperate region could use either 0°C or 5°C for the exterior temperature. Note that the cool-temperate region includes Vancouver, Ottawa, and Montreal; colder regions in Canada are either “cold” or “arctic.”
- Surface heat transfer resistances are given for various conditions

Note that the standard window size is just for certifying components, and the actual sizes are used to certify Passive House buildings within the PHPP software.

The certification criteria does not specifically address maximum U-values for frame components, but gives maximum values for the overall window, the glazing, and the installed window. For the cool-temperate climate, which includes Vancouver and Montreal, these values are U-0.80 for the whole window, U-0.75 for the glass, and U-0.85 for the installed window. Products with lower U-values can achieve higher “efficiency class” ratings.

The Passive House Institute US (PHIUS) has also recently begun a program to certify windows, “PHIUS Certified Product Performance Data.” Certified values will be published on the PHIUS website, however details of certification criteria are not available at the time of this report.

The paper “Calculating Window Performance Parameters for Passive House Energy Modeling” by Graham Wright, Technical Committee Chair of Passive House Institute US (PHIUS), provides details on how to perform window U-value calculations according to Passive House requirements using the programs WINDOW and THERM. The article also discusses the difference between the edge of glass U-value and  $\Psi$ -spacer values, as well as the impact of different standard sizes. The article suggests that it may be possible to develop a correlation between the NFRC/CSA U-edge and the ISO  $\Psi$ -spacer, and that the issue of different standard sizes may not be significant.

The Passive House Planning Package (PHPP) is a spreadsheet-based software tool that is used to design and assess Passive House buildings. In version 1.0 there are two sheets within the software related to windows: “WinType” and “Windows.” On the “WinType” tab the user enters each glazing and frame type present in the building, along with the corresponding parameters from the window product certification (U-values,  $\Psi$ -values, and g-value). On the “Windows” tab, the user enters the quantity, orientation and dimensions of windows at the building. The user also selects the glass and frame type from the “WinType” tab. The spreadsheet then calculates the overall window U-value, as well as the total overall transmission losses and solar heat gains through the window (in kWh/year) for the specific climate and shading at the building site. The program’s calculations are based on separate values entered for the frame, edge losses (linear transmittance), and centre of glass for both U-value (thermal transmittance) and solar heat gain.

In addition to the energy performance requirements, Passive House also has hygiene requirements (to prevent condensation and mould) and comfort requirements for windows. The Passive House certification criteria for residential buildings include requirements that the building contain operable windows in all living areas, low overheating (less than 10% of hours in a year over 25°C), and user-adjustable ventilation and temperatures.

### **2.3.2 ift Rosenheim Directive WA-15/2 Window Certification Criteria**

To meet the requirements of German building codes, fenestration products may be evaluated according to *Directive WA-15/2 Suitability of windows, exterior doors and curtain walling for Passive Houses* published by ift Rosenheim in Germany. This standard establishes window thermal performance requirements that are nearly identical to those of the PHI including an overall window U-value of  $U_w \leq 0.80 \text{ W/m}^2\text{-K}$  (simulated using glazing with a centre of glass value of  $U_g = 0.7 \text{ W/m}^2\text{-K}$ ) and an installed window U-value of  $U_{w,installed} \leq 0.85 \text{ W/m}^2\text{-K}$ .

There are two main differences between the Rosenheim directive and the PHI window certification requirements. While PHI uses climate-dependant exterior boundary conditions and 20°C interior, WA-15/2 uses the ISO boundary conditions of 0°C exterior and 20°C interior. And while PHI determines frame U-value by simulation according to EN ISO 10077-1, the Rosenheim directive permits frame U-values to be determined by either simulation to EN ISO 10077-1 or by physical “hot box” testing to EN 12412-2. Most German manufacturers reportedly utilize hot box testing as it yields lower U-values than those determined by simulation.

Because hot box testing is performed with a glazed window, glass with U-values lower than the specified reference glass used for simulations can be used. This allows products with higher frame U-values to achieve the specified overall U-values. For this reason PHI and Rosenheim Passive House certificates are not comparable.

North American Passive House designers should be aware that some German fenestration products marketed as qualified for Passive House use may actually be qualified under Rosenheim WA-15/2. These products have achieved this qualification using different methods than products certified by PHI.

## **2.4. Comparison of Standards**

The literature review of the various standards related to window thermal performance has identified several key differences between standards. This list is not comprehensive, as the intent of this report is not to provide an exhaustive list of technical

differences between the various methodologies or a simulation manual; however the important differences are identified and discussed as follows.

- ..... Boundary conditions
- ..... Calculating solar heat gain
- ..... Methods of accounting for edge of glass effects
- ..... Reference sizes
- ..... Treatment of sloped glazing
- ..... Installation  $\Psi$ -values

### 2.4.1 Boundary Conditions

There are significant differences in the boundary conditions used to determine U-values and solar heat gain ratings in the various standards. Table 2.1 shows the exterior and interior surface temperature boundary conditions that were identified in the standards reviewed. For U-value calculations, NFRC/CSA standards use the lowest exterior temperature, while Passive House certification criteria use an exterior temperature that varies by climate zone. For SHGC calculations, NFRC/CSA uses a higher solar radiation value.

Table 2.1 Exterior and interior surfaces temperatures for U-value and SHGC calculations.

	U-value		Solar Heat Gain		
	Exterior Temperature	Interior Temperature	Exterior Temperature	Interior Temperature	Solar Radiation
NFRC 100 & 200	-18°C	21°C	32°C	24°C	783 W/m <sup>2</sup>
ISO 10077-2	0°C	20°C	n/a	n/a	n/a
ISO 15099	0°C	20°C	30°C	25°C	500 W/m <sup>2</sup>
Passive House Certification Criteria	Frame: -10°C Glazing: 20°C to -7°C (climate dependant)	20°C (EN 410)	30°C (EN 410)	25°C (EN 410)	500 W/m <sup>2</sup> (EN 410)

Table 2.2 shows the exterior and interior surface film coefficients for U-value calculations of vertical windows, from the various standards that were reviewed. Exterior surface film coefficients vary from a high of 26.0 W/m<sup>2</sup>-K in NFRC 100, to 25.0 W/m<sup>2</sup>-K in ISO 10077-1, to a low of 20.0 W/m<sup>2</sup>-K in ISO 15099. The interior surface film coefficients are reported either as a combined (convective and radiative) coefficient, or as convection only (a radiation model is included in the heat transfer simulation). The NFRC 100 standard uses slightly different convective coefficients depending on the window frame type (ranging from 2.44 to 3.29 W/m<sup>2</sup>-K); other standards use a convective film coefficient of 3.6 W/m<sup>2</sup>-K.

Table 2.2 Standard surface film coefficients for U-value calculations, vertical glazing.

	Exterior, W/m <sup>2</sup> -K	Interior, W/m <sup>2</sup> -K	Notes
NFRC 100 Interior Aluminum Frame Interior Thermally Broken Frame Interior Thermally Improved Frame Interior Wood/Vinyl frame (frame and edge of glass simulations)	26.0	3.29 3.00 3.12 2.44	Radiation model – automatic enclosure model for interior frame surfaces, blackbody for exterior surfaces. (Interior coefficients are convection only) Glazing system boundary conditions depend on the WINDOW calculations for the imported glazing system.
ISO 10077-1	25	7.7	“For typical normal emissivities ( $\geq 0.8$ ) for the inside and outside surfaces of the glazing, the following values for the surface resistances shall be used.” Combined convection and radiation coefficient. Increased surface resistance modeled at corners to account for reduced radiation/convection heat transfer.
ISO 15099	20	3.6	Convective heat transfer coefficient. “Unless a specific set of boundary conditions is of interest (e.g., to match test conditions, actual conditions or to satisfy a national standard), the following standard boundary conditions shall be used.”
EN 673 (centre of glass simulations)	25	7.7	“For ordinary vertical glass surfaces the value of $h_e$ is standardised to 25 W/m <sup>2</sup> -K for the purposes of comparison of glazing U-values.” “For vertical soda lime glass surfaces and free convection, $h_i = 7.7$ W/m <sup>2</sup> -K which is standardised for the purposes of comparison of glazing U-values.” Combined convection and radiation coefficient. Interior convective coefficient is $h_c = 3.6$ W/m <sup>2</sup> -K.
ISO 10292 (centre of glass simulations)	23	8	“The value $h_e$ equal to 23 W/m <sup>2</sup> -K ( $h_i$ equal to 8.0) is used for the purposes of comparison of glazing U-values.” Combined convection and radiation coefficient. Interior convective coefficient is $h_c = 3.6$ W/m <sup>2</sup> -K.
Passive House Institute Window Certification Criteria	25	7.7	Combined convection and radiation coefficient. Increased surface resistance modeled at corners to account for reduced radiation/convection heat transfer.

Most of the standards do not include separate surface film coefficients for SHGC calculations. The exception to this is ISO 15099, which specifies an interior surface film coefficient of 2.5 W/m<sup>2</sup>-K and an exterior surface film coefficient of 8.0 W/m<sup>2</sup>-K for “summer conditions.”

#### 2.4.2 Solar Heat Gain

The different standards appear to use similar calculation methodologies for solar heat gain. However, NFRC 200 identifies different boundary conditions for solar heat gain calculations than ISO 15099 and PHI (see Section 2.4.1). Another important difference is that the NFRC/CSA Solar Heat Gain Coefficient (SHGC) refers to a whole product value (including glazing and frame), whereas the g-value required for Passive House is centre of glass only. The solar energy transmittance calculation in ISO 15099 is

for the whole product, while the g-value referenced in ISO 18292 may be calculated for either the whole product or centre of glass only.

### **2.4.3 Centre of Glass Heat Transfer**

The NFRC/CSA centre of glass U-value calculation follows ISO 15099 algorithms, while the ISO calculation follows ISO 10077 and EN673. These standards use different calculations methods. The two methods are described in the document “TARCOG: Mathematical Models for Calculation of Thermal Performance of Glazing Systems With or Without Shading Devices” (Carli Inc., 2006). The ISO 15099 (NFRC/CSA) calculation is based on a comprehensive heat transfer model, including conductive, convective and radiative heat transfer. A system of energy balance equations is developed, and surface temperatures and heat flux at each layer is solved using numerical methods. The ISO 10077-1 / EN673 algorithms are simplified compared to the ISO 15099 calculations. Properties are evaluated at the mean temperature difference across the gas space; for double glazed systems, this is fixed at a temperature difference of 15 K.

### **2.4.4 Edge of Glass Heat Transfer**

The NFRC/CSA calculation methods account for the edge of glass and spacer heat transfer using an edge of glass U-value calculated in a two-dimensional heat transfer simulation program (THERM). The ISO 10077 and related standards use a linear thermal transmittance or  $\Psi$ -value to account for this heat transfer.

### **2.4.5 Standard Sizes**

In North America, NFRC 100 and CSA A440.2 use the same standard window sizes. Sliding, dual-action and fixed windows have a standard size of 1.2 m wide x 1.5 m high, single casement is 0.6 m x 1.5 m, while awning, and hopper windows are 1.5 m x 0.6 m. Double casements with one or two operating panels are only rated together (i.e. as double) when single units are not manufactured. The NFRC and A440 sizes do not include mullions.

By comparison, BRE 443 and Passive House standard size windows are 1.23 m wide by 1.48 m high for windows in a vertical façade. There are also other differences between European/Passive House and North American sizes for other fenestration types (doors, skylights, etc.). The British assembly has a central divider, with one opening lite and one fixed lite. The Passive House U-value and  $\Psi$ -value calculations include only the bottom, top and sides, though mullion U-values and  $\Psi$ -values are provided for information.

### **2.4.6 Sloped Glazing**

The various standards deal with glazing intended for installation at a slope differently. Following NFRC/CSA standards, skylights and other sloped glazing products are simulated at an angle of 20° above the horizontal. Following ISO standards, thermal performance parameters are calculated in a vertical position for the purpose of comparing products. Passive House certification criteria require roof windows are to be modeled at a 45° inclination. These differences are significant as they affect the calculated U-value. Sloping of an IGU from vertical reduces thermal performance due to increased convective heat transfer between the panes of glass and is therefore an important factor to consider in true thermal performance of a skylight.

### **2.4.7 Installation $\Psi$ -values**

Passive House is the only one of the standards evaluated in this literature review that incorporates the thermal performance of the window installation, via an installation  $\Psi$ -value. This value is not included in the ISO 10077 standard that is referenced by Passive House for calculating window thermal performance. However, Passive House does reference ISO 10211 *Thermal bridges*

*in building construction – Heat flows and surface temperatures – Detailed calculations* for the calculation of the installation  $\Psi$ -value. This value can be calculated using a two-dimensional heat transfer simulation program.

## **2.5. Window Inputs to Whole Building Energy Modeling Programs**

The energy performance of windows is typically assessed together with the other building components and systems when performing whole building energy modeling. Various energy modeling programs require different window thermal performance inputs, such as requiring component U-values versus overall U-values, or selecting fenestration components from a database.

Two programs that can be used to model whole single family dwellings in Canada are HOT2000 and the Passive House program PHPP. PHPP requires the input of a rated centre of glass (ISO or PHI) U-value, frame U-value, edge of glass linear transmittance, installation linear transmittance, and the glazing g-value (solar heat gain). Actual window dimensions are also entered into the program.

In HOT2000, windows can be defined either by selecting a set of characteristics and having the program determine the approximate NFRC/CSA U-value (e.g. double glazed, wood frame, argon gas fill, etc.), or by entering the centre of glass, edge of glass and frame U-values plus the frame height and centre of glass SHGC.

In the United States, houses are commonly rated using the Home Energy Rating System (HERS) Index, which is administered by Residential Energy Services Network (RESNET). There are several approved software programs for determining HERS Index ratings. An analysis of how windows are defined in each of these programs is beyond the scope of this report, however the HERS Index requires that windows have a rated NFRC U-value (of the complete assembly) and SHGC.

RESFEN is an LBNL program that compares heating and cooling energy use for different window products in houses. Users specify the NFRC U-value, SHGC, and air leakage rate of the windows, as well as other information about the house (e.g. size, location, fuel costs, etc.). RESFEN uses the DOE2 engine to perform hourly energy calculations. RESFEN can use results generated by WINDOW to define the windows (which more accurately accounts for SHGC variation with solar angle), or a user can enter the U-value and SHGC of windows.

Hourly energy modeling programs such as eQuest or EnergyPlus often have two options for defining windows: a simple method of entering the overall product U-value and SHGC, or a more detailed method of selecting glass layers from the International Glazing Database (IGDB) plus entering frame details (including frame U-value). Some programs allow the user to import a file from WINDOW to define the glazing; the program then calculates the overall NFRC/CSA U-value. While these programs do not specify whether an NFRC/CSA or ISO U-value is to be entered, NFRC/CSA U-values are typically used in North American whole building energy models.



### 3. NFRC/CSA, CEN and PHI U-value Calculations

#### 3.1. Windows Simulated



U-value and solar heat gain calculations were performed for two representative North American windows, one with a vinyl frame and the other a fiberglass frame, and a European window with a vinyl (uPVC) frame. Each window was simulated under NFRC/CSA and ISO boundary conditions. Note that ISO boundary conditions are also acceptable for PHI simulations in the cold-temperate climate zone. Other PHI boundary conditions that vary by climate zone were not simulated.

Table 1 shows a summary of the window configurations simulated for this study. The frames were simulated with the following six Insulated Glazing Units (IGUs) using glass and spacers from Cardinal IG:

- Double glazed with Cardinal LoE-180 on surface 3
- Double glazed with Cardinal LoE-366 on surface 2
- Double glazed with Cardinal LoE-180 on surface 2 and LoE-i89 on surface 4 (exposed inside surface)
- Double glazed with Cardinal LoE-366 on surface 2 and LoE-i89 on surface 4 (exposed inside surface)
- Triple glazed with Cardinal LoE-180 on surfaces 2 and 5
- Triple glazed with Cardinal LoE-366 on surface 2 and LoE-180 on surface 5

The same IGUs were used for all simulations to allow for comparison between products.

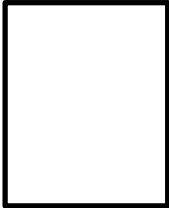
Table 1 Summary of Window Configurations

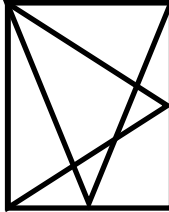
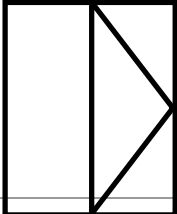
Label		Description of Window	Label		Description of Window
A	NFRC/CSA Fixed (Picture)	1200 mm wide by 1500 mm high 	D	Passive House Fixed	1230 mm wide by 1480 mm high 
B	NFRC/CSA Casement	600 mm wide by 1500 mm high 	E	Passive House Dual Action	1230 mm wide by 1480 mm high 
C	British Coupled	1230 mm wide by 1480 mm high, one fixed lite and one casement lite 			

--	--	--	--	--	--

Glass thickness and gap sizes were based on the standard insulating glass thickness of each product, based on the window manufacturers' drawings. The low-e coatings have the following NFRC/CSA-calculated emissivities: LoE-180 emissivity is 0.068, LoE 366 emissivity is 0.022, i89 emissivity is 0.149. These sets of coatings were chosen to simulate glazing with higher and lower solar heat gain. Each IGU has argon gas fill, assuming 90% argon and 10% air fill per Cardinal's simulation directions. The same spacer was used in all simulations, a dual seal (PIB primary/silicone secondary) thin-wall stainless steel spacer (Cardinal XL Edge).

The glazing units were simulated using spectral data from the International Glazing Database (IGDB), through the program WINDOW. Although ISO calculation procedures yield different emissivities for glazing, the spectral data for the glass remains the same and the difference results from the calculation functions<sup>2</sup>. In other words, the same IGDB glass entries are used for both NFRC/CSA and ISO calculations. The different emissivities in the two calculation procedures is captured when the program WINDOW is used to simulate IGUs set to use either NFRC/CSA or ISO procedures.

### 3.2. Methodology

NFRC/CSA simulations were performed following NFRC guidelines, as documented in "THERM 6.3 / WINDOW 6.3 NFRC Simulation Manual" (Lawrence Berkeley National Laboratory, 2011). The software programs WINDOW 6.3 and THERM 6.3 were used for the NFRC/CSA calculations.

ISO simulations were completed following the procedure outlined in "Calculating Fenestration Product Performance in WINDOW 6 and THERM 6 According to EN 673 and EN 10077" (Lawrence Berkeley National Laboratory, 2012) and the associated spreadsheet, with the following exceptions. The software versions WINDOW 7.1 and THERM 7.1 were used since WINDOW 7.1 has the functionality required to perform EN 673 calculations, and this functionality does not work in Version 6.3. Also, the exterior combined surface film coefficient used was 25 W/m<sup>2</sup>-K per ISO 10077-1 and EN 673, instead of 23 W/m<sup>2</sup>-K shown in the document.

Several window configurations were also simulated independently by a German simulator using their standard software to verify the results in this study. The results were generally within 5% difference and less.

### 3.3. Window 1 – North American Vinyl Frame

The first window simulated is a North American vinyl frame. This window was selected since it is representative of a typical residential window in Canada. The IGU has 3 mm glass in both the double and triple glazed units, with a 15.875 mm gap in the double glazed unit and 12.7 mm gaps in the triple glazed units. The glazing was simulated in accordance with manufacturers' drawings. It should be noted that the depth of glass embedment into the frame has an effect on U-values, however all simulations for this study were performed according to the manufacturer's drawings. Frame E (dual action) was not simulated for this product since it does not have a dual action operator type.

---

<sup>2</sup> Cardinal Glass Industries. (2013) Correspondence with Jim Larsen, Director Technology Marketing.

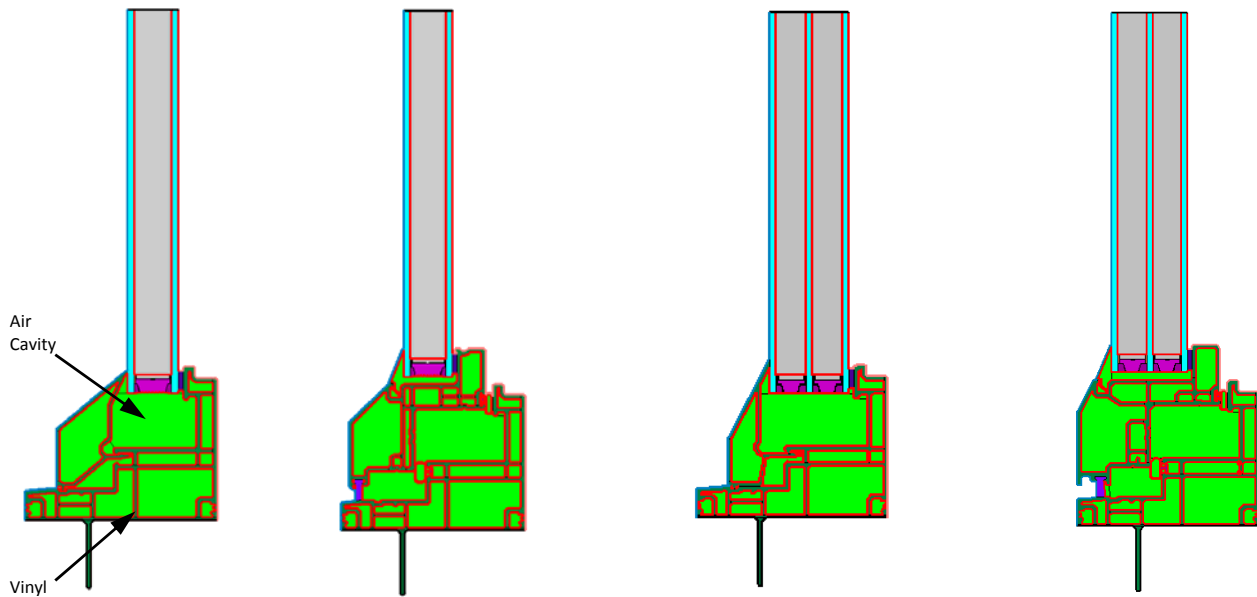
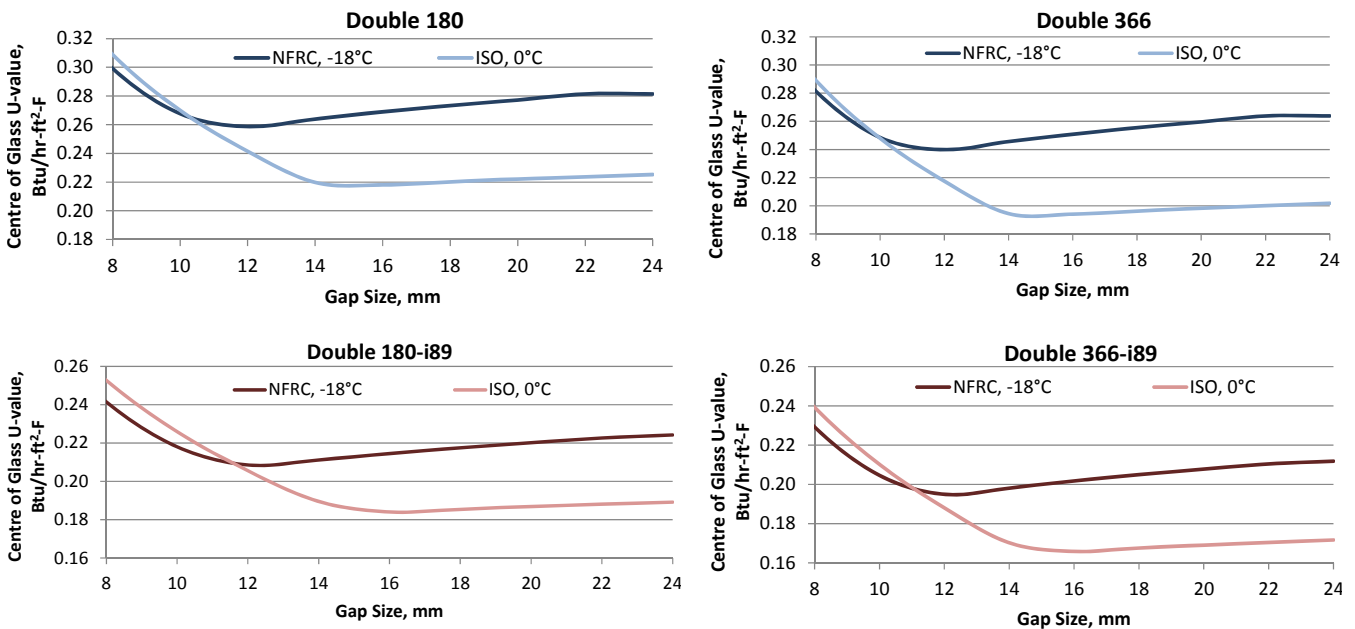

Fig.3.1 THERM models for sills of vinyl frame window: double glazed fixed (picture) and casement, and triple glazed fixed (picture) and casement (left to right).

### 3.3.2 Centre of Glass U-value versus Gap Size

Fig.3.2 shows plots of the centre of glass U-value versus gap size using NFRC/CSA and ISO simulation procedures. These results were generated using WINDOW version 6.3 for NFRC/CSA simulations and version 7.1 for ISO simulations. All IGUs have argon gas fill, with 90% argon and 10% air. Note that NFRC/CSA simulations are performed with an outdoor temperature of -18°C, while ISO simulations are performed at an outdoor temperature of 0°C (among other calculation differences, such as surface films). The heat loss associated with argon gas convection is different between NFRC/CSA and ISO methods. The optimum gap using NFRC/CSA methods is typically smaller than determined using ISO methods.



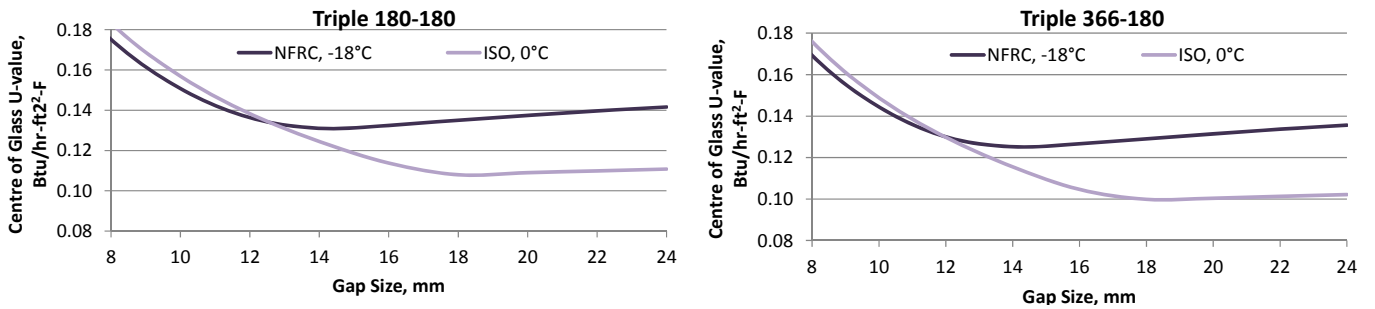

Fig.3.2 Plots of centre of glass U-value versus gap size for vinyl frame window IGU simulations with ISO and NFRC/CSA calculation procedures.

Fig.3.3 shows the centre of glass U-values for different gap sizes with NFRC/CSA and ISO procedures using different exterior boundary conditions to show the effect of changing only the exterior temperature. For example, an NFRC/CSA simulated unit with a gap size of 14 mm at standard -18°C conditions has a higher U-value than the same simulation run at 0°C. An IGU with an 18 mm gap has a U-value of approximately 0.10 at standard ISO conditions of 0°C; by comparison, the same unit simulated at -18°C has a higher U-value of 0.12. The difference in values occurs as a result of both boundary conditions and the different calculation algorithms.

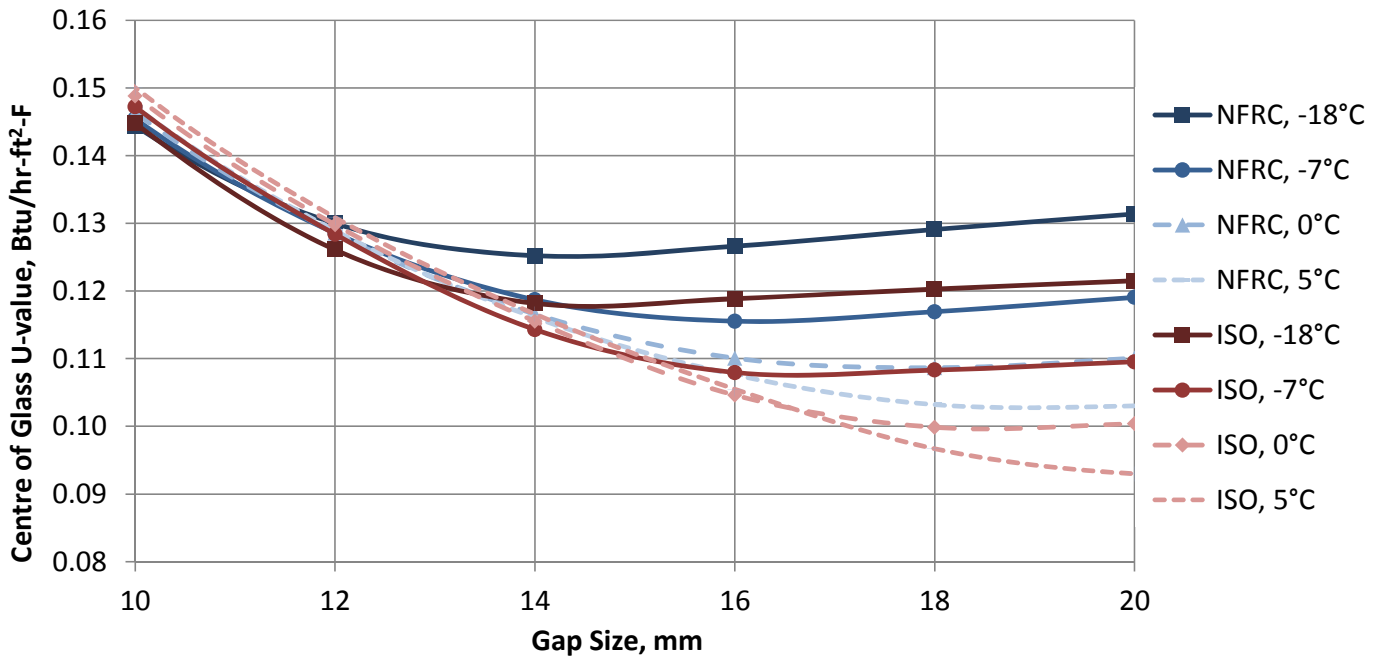

Fig.3.3 Plots of centre of glass U-value versus gap size for NFRC/CSA and ISO procedures using different exterior boundary conditions.

### 3.3.3 Centre of Glass U-value

Fig.3.4 shows the centre of glass U-values for each IGU simulated using NFRC/CSA and ISO procedures, and Table 3.1 shows the percent difference. The double glazed values have the greatest difference, where NFRC/CSA U-values are highest and ISO U-values are lowest. The triple glazed IGU U-values are close between each system. This is likely due to the smaller gap size (12.7 mm) which is optimal for NFRC/CSA but not for ISO.

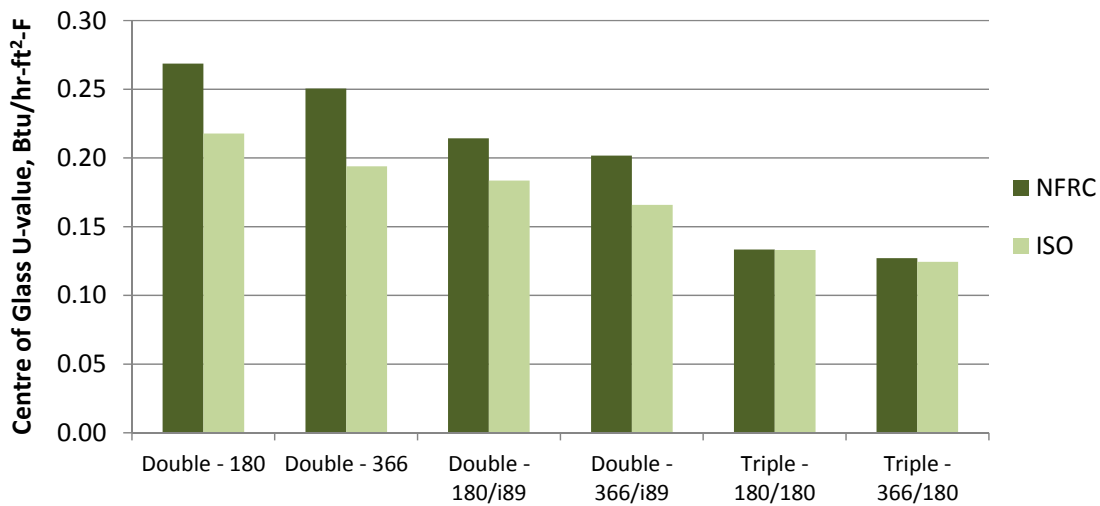

Fig.3.4 Centre of glass U-value simulated using NFRC/CSA, ISO and PHI procedures.

Table 3.1 Percent difference between NFRC/CSA and ISO centre of glass U-values.

	Percent Difference between NFRC/CSA and ISO (positive indicates higher NFRC/CSA)
Double – 180	19%
Double – 366	23%
Double – 180/i89	14%
Double – 366/i89	18%
Triple – 180/180	0%
Triple – 366/180	2%

### 3.3.4 Frame U-values

Fig.3.5, Fig.3.6 and Fig.3.7 show the frame U-values for the fixed (picture) window frame components simulated using NFRC/CSA and ISO conditions. Results for the casement and mullion components are similar. The NFRC/CSA frame U-values are higher than the ISO values. This result occurs because the NFRC/CSA frame U-value is simulated with the actual IGU, whereas the ISO frame U-value is simulated with the calibration panel with a lower thermal conductivity than the IGU, giving a better (lower) U-value for the ISO frame.

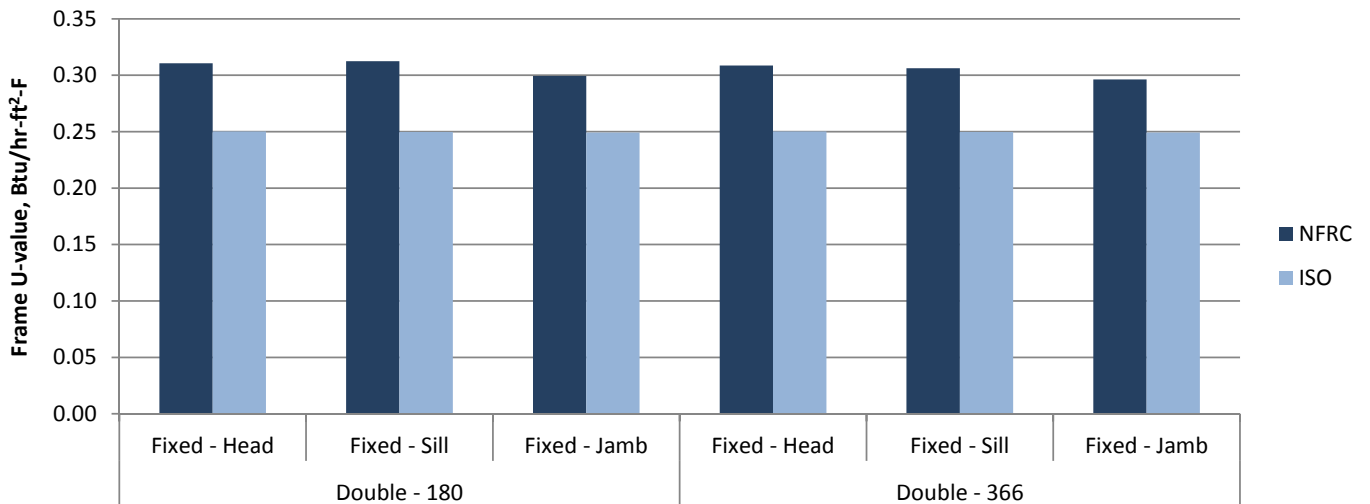

Fig.3.5 Frame U-value simulated using NFRC/CSA and ISO procedures for the fixed (picture) frame components.

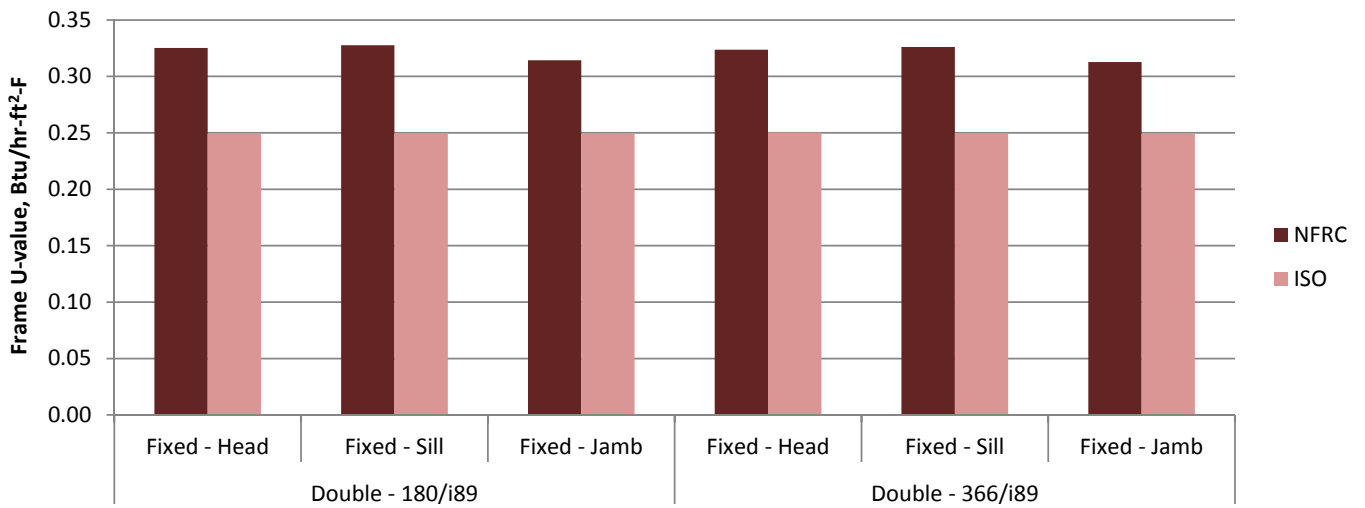

Fig.3.6 Frame U-value simulated using NFRC/CSA and ISO procedures for the fixed (picture) frame components.

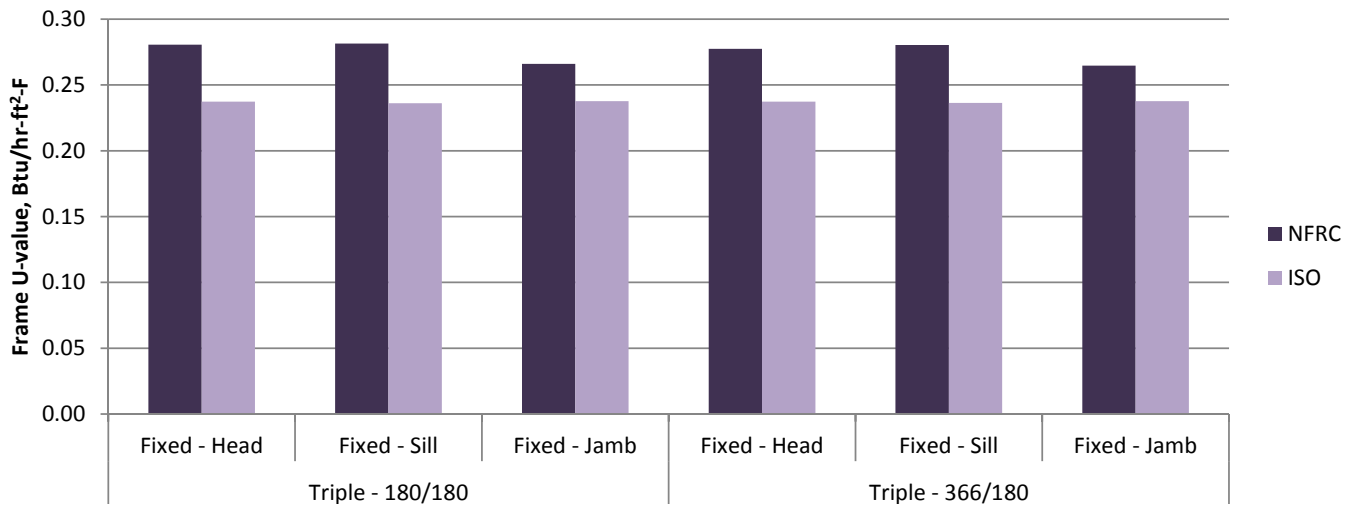

Fig.3.7 Frame U-value simulated using NFRC/CSA and ISO procedures for the fixed (picture) frame components.

A comparison of edge of glass values is not shown, since the ISO whole window calculations use a linear transmittance ( $\Psi$ ) value, calculated from the actual IGU simulation and a calibration panel simulation. The NFRC/CSA edge of glass value uses only the actual IGU, and does not use a calibration panel. For this study, an ISO spreadsheet (provided by LBNL) was used to calculate the  $\Psi$ -value and the overall ISO window U-value from the THERM and WINDOW simulation results for the IGU and calibration panel simulations (specifically, the U-values and projected frame dimensions). However, there is no true comparison between NFRC/CSA and ISO edge of glass values since the two methods use different simulations and calculations.

### 3.3.5 Whole Product U-value

The whole window U-value simulation results for the North American vinyl frame double and triple glazed windows are shown in Fig.3.8, Fig.3.9 and Fig.3.10. Table 3.2 shows the percent difference between the NFRC/CSA and ISO simulated U-values.

For the double glazed windows, the NFRC/CSA U-values are consistently higher than the ISO U-values, with percent differences ranging from 5% to 16%. For the triple glazed windows the results are very close. The NFRC/CSA U-value is slightly higher than ISO U-values for all cases except frame B (the NFRC/CSA casement type), where the NFRC/CSA U-value is slightly lower. The triple glazed values are likely closer than the double glazed values due to the smaller gap spacing, which is optimal for NFRC/CSA calculations but not for ISO calculations (refer to Fig.3.3).

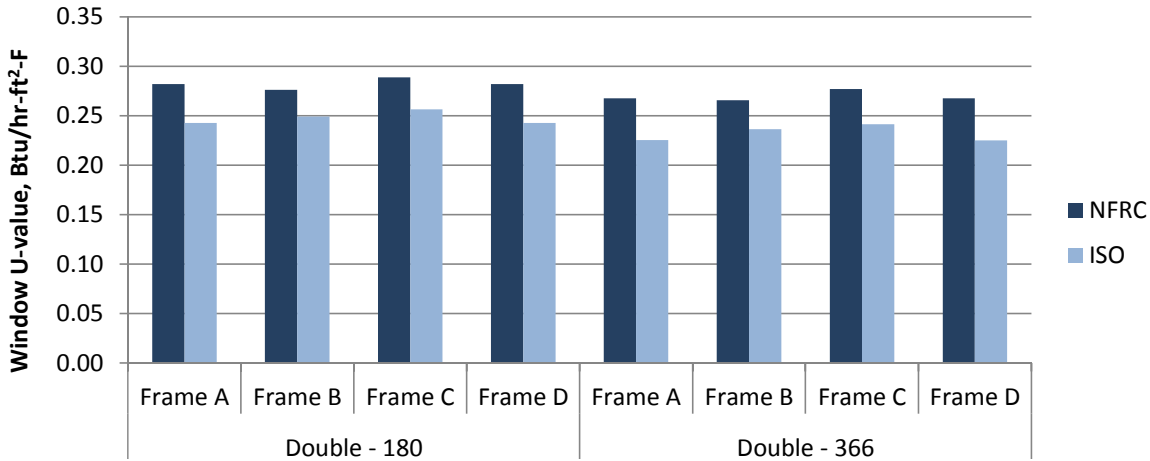

Fig.3.8 Window U-values for vinyl frame double glazed with one low-e coating, Btu/hr-ft²-F.

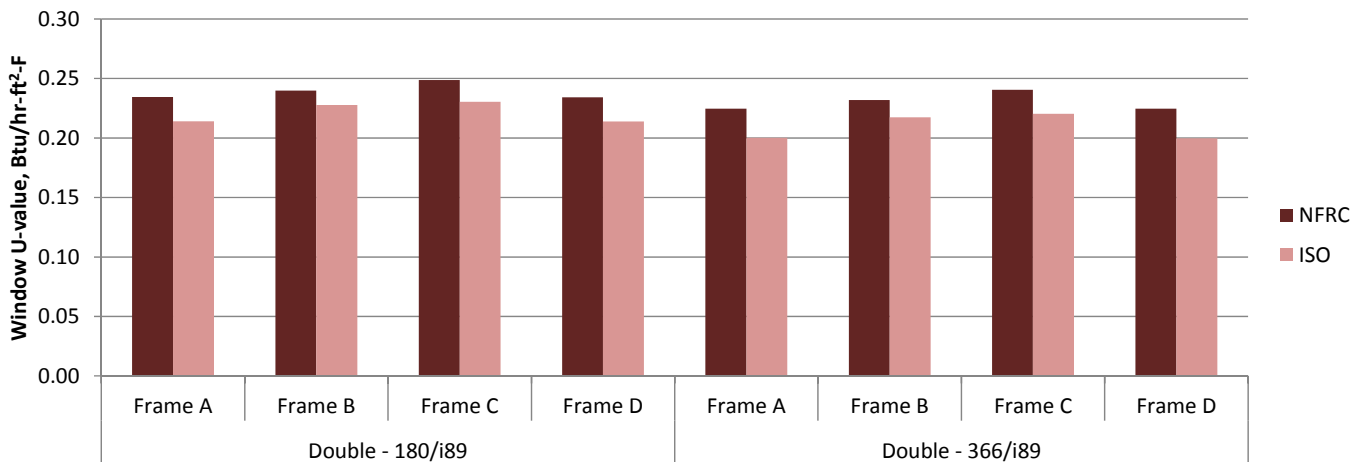

Fig.3.9 Window U-values for vinyl frame double glazed with surface four low-e coating, Btu/hr-ft<sup>2</sup>-F.

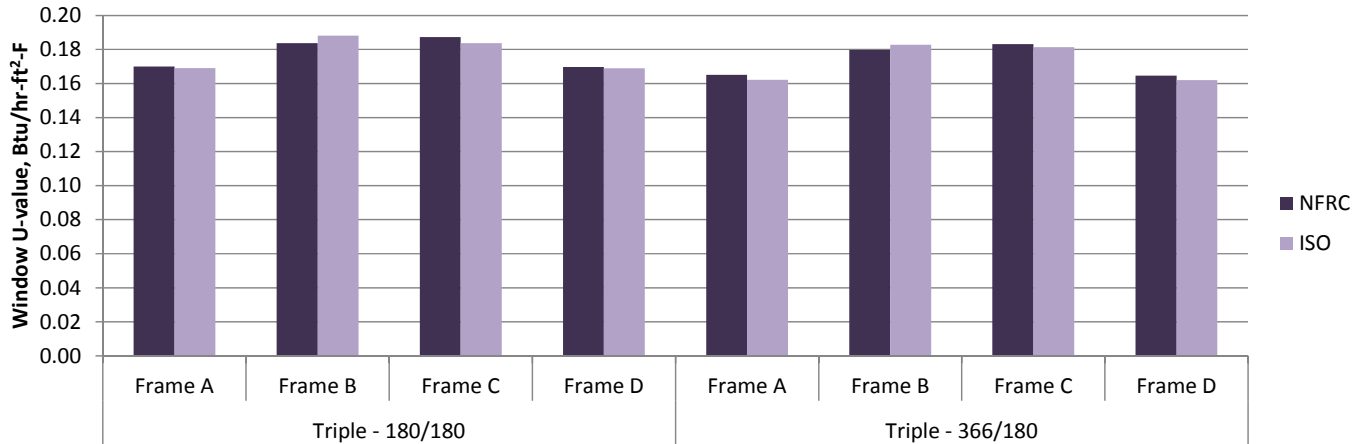

Fig.3.10 Window U-values for vinyl frame triple glazed with two low-e coatings, Btu/hr-ft<sup>2</sup>-F.

Table 3.2 Percent difference between NFRC/CSA and ISO whole window U-values; positive indicates higher NFRC/CSA U-value.

	Frame A	Frame B	Frame C	Frame D
Double - 180	14%	10%	11%	14%
Double - 366	16%	11%	13%	16%
Double - 180/i89	9%	5%	7%	9%
Double - 366/i89	11%	6%	8%	11%
Triple - 180/180	1%	-2%	2%	1%
Triple - 366/180	2%	-2%	1%	2%

### 3.3.6 Solar Heat Gain Coefficient

Table 3.3 and Fig.3.11 show the resulting solar heat gain coefficients following NFRC/CSA and ISO calculation procedures. The ISO solar heat gain, or “g-value,” is typically reported as centre of glass solar heat gain. The NFRC/CSA and ISO centre of glass values are shown, plus the whole product values for comparison. Note that the NFRC/CSA simulation uses an outdoor temperature of 32°C and incident direct solar radiation of 783 W/m<sup>2</sup>, while the ISO simulation uses an outdoor temperature of 30°C and incident direct solar radiation of 500 W/m<sup>2</sup>.

The centre of glass SHGCs are close between ISO and NFRC/CSA procedures, with 1% difference for the IGUs with LoE-180, and 6% to 8% difference between the IGUs with LoE-366. The results show a greater difference between the two procedures for the lower solar heat gain IGU. It was also noted that the interior surface temperature predicted by the software is higher for ISO calculations than for NFRC/CSA calculations. For example, the double glazed LoE-366 window has an interior surface temperature of 28.1°C using NFRC/CSA, and 25.7°C using ISO.

Table 3.3 Solar heat gain calculated following NFRC/CSA and ISO procedures; all whole window values are calculated following NFRC/CSA procedures.

	Centre of Glass Solar Heat Gain			Whole Window NFRC/CSA SHGC			
	NFRC	ISO	% Difference	NFRC Fixed (Picture) (Frame A)	NFRC Casement (Frame B)	Coupled (Frame C)	PHI Fixed (Frame D)
Double - 180	0.69	0.70	-1%	0.56	0.45	0.48	0.56
Double - 366	0.27	0.29	-6%	0.22	0.18	0.19	0.22



Double - 180/i89	0.63	0.63	-1%	0.51	0.41	0.44	0.51
Double - 366/i89	0.27	0.29	-7%	0.22	0.18	0.19	0.22
Triple - 180/180	0.56	0.57	-1%	0.46	0.37	0.40	0.46
Triple - 366/180	0.24	0.26	-8%	0.20	0.16	0.18	0.20

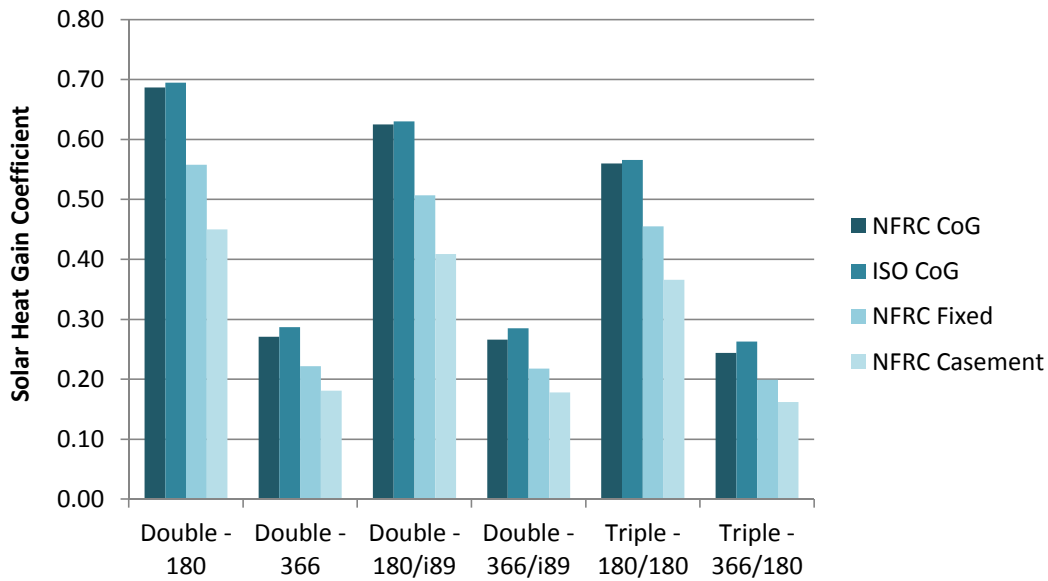

Fig.3.11 Centre of glass and whole product SHGC values.

### 3.4. Window 2 – North American Fiberglass Frame

The second window simulated is a North American fiberglass frame. The IGU has 5 mm glass in the double glazed units, and 4 mm glass in the triple glazed units, with a 15.875 mm gap in the double glazed unit and 12.7 mm gaps in triple glazed units. The glazing was simulated in accordance with manufacturers’ drawings. It should be noted that burying the glazing deeper into the frame would change the U-values, however all simulations for this study were completed per the manufacturers drawings.

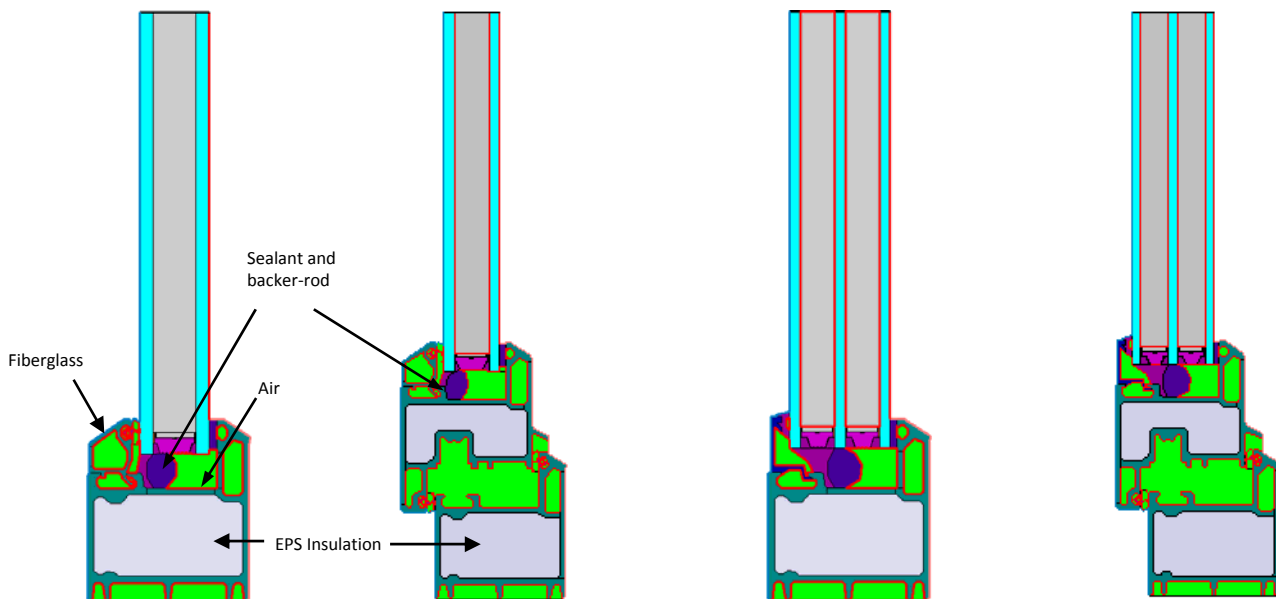

Fig.3.12 THERM simulation of fiberglass frame double glazed fixed (picture) and casement sill, and triple glazed fixed (picture) and casement sill (left to right).

### 3.4.2 Centre of Glass U-value

Fig.3.13 shows the centre of glass U-values for each IGU simulated using NFRC/CSA and ISO procedures, and Table 3.4 shows the percent difference. The double glazed values have the greatest difference, where NFRC/CSA U-values are highest and ISO U-values are lowest. The triple glazed IGU U-values are close between each system. This is likely due to the smaller gap size (12.7 mm) which is optimal for NFRC/CSA but not for ISO.

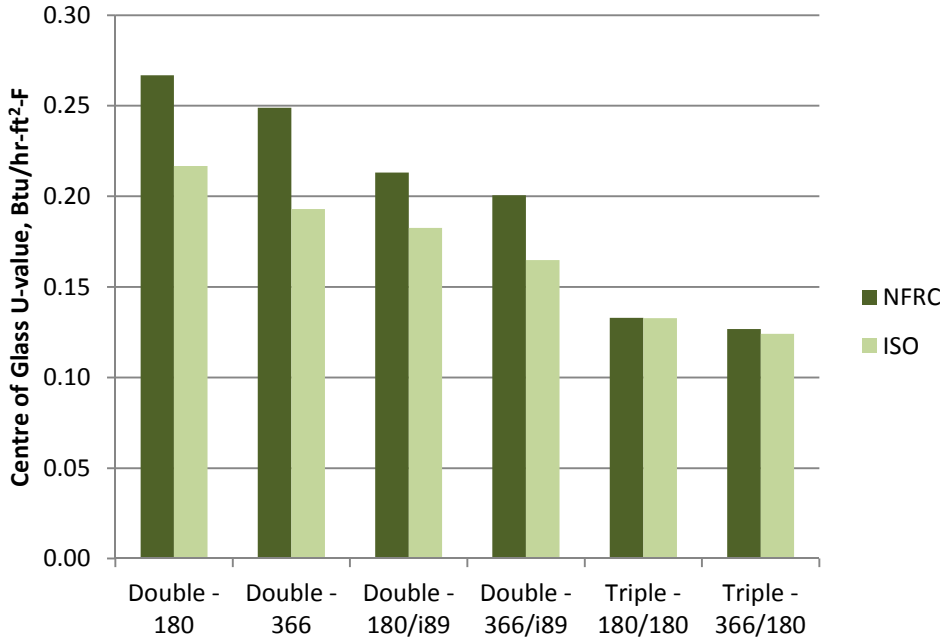

Fig.3.13 Centre of glass U-value simulated using NFRC/CSA, ISO and PHI procedures.

Table 3.4 Percent difference between NFRC/CSA and ISO centre of glass U-values.

	Percent Difference between NFRC/CSA and ISO (positive indicates higher NFRC/CSA)
Double – 180	19%
Double – 366	22%
Double – 180/i89	14%
Double – 366/i89	18%
Triple – 180/180	0%
Triple – 366/180	2%

### 3.4.3 Frame U-values

Fig.3.14, Fig.3.15 and Fig.3.16 show the frame of glass U-values for the fixed (picture) window frame components simulated using NFRC/CSA and ISO conditions. Results for the casement, mullion and tilt and turn components are similar.

The NFRC/CSA frame U-values are higher than the ISO values for the double glazed windows, and lower for the triple glazed windows. This occurs as a result of several factors. First, the NFRC/CSA frame U-value is simulated with the actual IGU, whereas the ISO frame U-value is simulated with the calibration panel with a lower thermal conductivity than the IGU, creating a better (lower) U-value for ISO conditions. Also, the NFRC/CSA and ISO simulations use different conductivity values for fiberglass, where the NFRC/CSA value is lower ( $k = 0.3 \text{ W/m-K}$ ) than the ISO value ( $k = 0.4 \text{ W/m-K}$ ), which results in a better (lower) NFRC/CSA U-value. If tested values are available for a manufacturer's material then tested values may be used, however in the absence of tested values these default material conductivities are used.

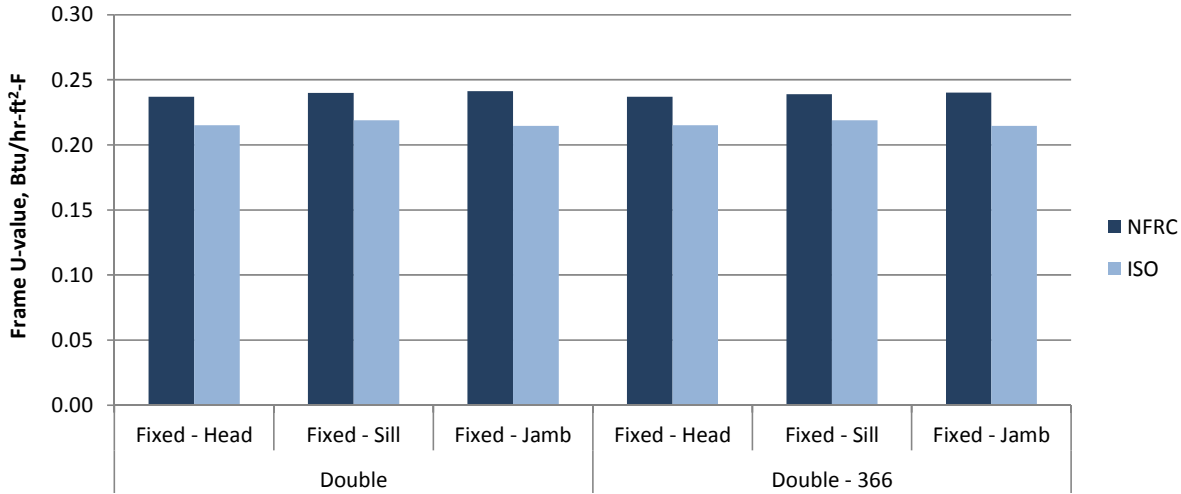

Fig.3.14 Frame U-value simulated using NFRC/CSA and ISO procedures for the fixed (picture) frame components.

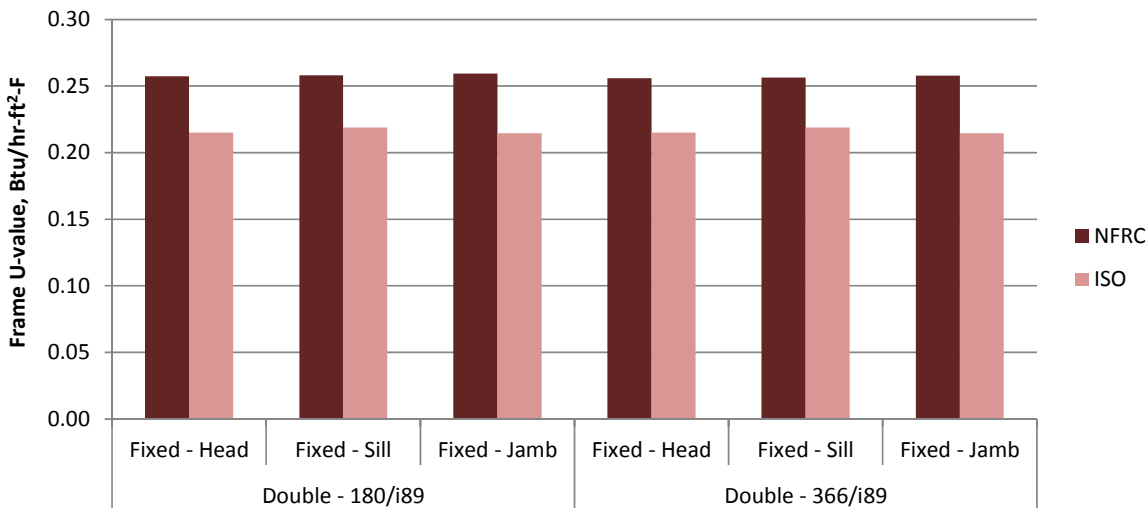

Fig.3.15 Frame U-value simulated using NFRC/CSA and ISO procedures for the fixed (picture) frame components.

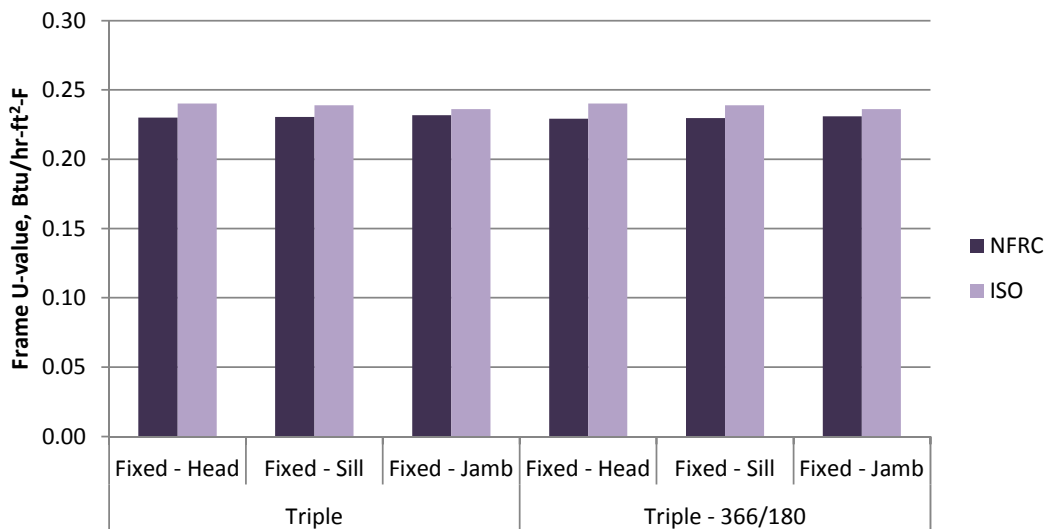

Fig.3.16 Frame U-value simulated using NFRC/CSA and ISO procedures for the fixed (picture) frame components.

A comparison of edge of glass values is not shown, since the ISO whole window calculations use a linear transmittance ( $\Psi$ ) value, calculated from the actual IGU simulation and a calibration panel simulation. The NFRC/CSA edge of glass value uses only the actual IGU, and does not use a calibration panel. For this study, an ISO spreadsheet (provided by LBNL) was used to calculate the  $\Psi$ -value and the overall ISO window U-value from the THERM and WINDOW simulation results for the IGU and calibration panel simulations (specifically, the U-values and projected frame dimensions). However, there is no true comparison between NFRC/CSA and ISO edge of glass values since the two methods use different simulations and calculations.

### 3.4.4 Whole Product U-value

The whole window U-value simulation results for the fiberglass frame double and triple glazed windows are shown in Fig.3.17, Fig.3.18 and Fig.3.19. Table 3.5 shows the percent difference between the NFRC/CSA and ISO simulated U-values.

For the double glazed windows, the NFRC/CSA U-values are generally higher than the ISO U-values, with percent differences ranging from 2% to 15%. The values for frame B (NFRC/CSA standard size casement) are close, and for the surface four low-e windows the NFRC/CSA values are lower than the ISO values. This is likely due to the greater influence of the frame, since the ISO simulations use a higher conductivity for fiberglass than the NFRC/CSA simulations. Note that the lower frame U-value that resulted due to the calibration panel should not be a factor in the overall window U-value, since this heat loss is accounted for in the edge linear transmittance calculation.

For the triple glazed windows, the NFRC/CSA U-values are all lower than the ISO U-values. This is likely due to the smaller gap size, which is optimized for NFRC/CSA conditions. The percent difference for the triple glazed windows ranges from 6% to 14%.

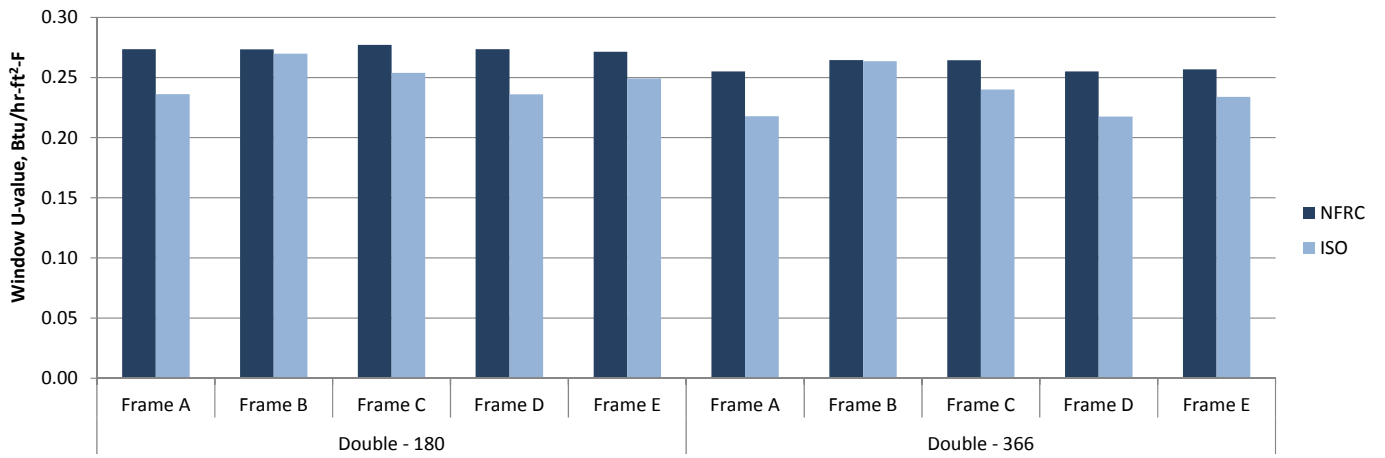

Fig.3.17 Window U-values for fiberglass frame double glazed with one low-e coating, Btu/hr-ft²-F.

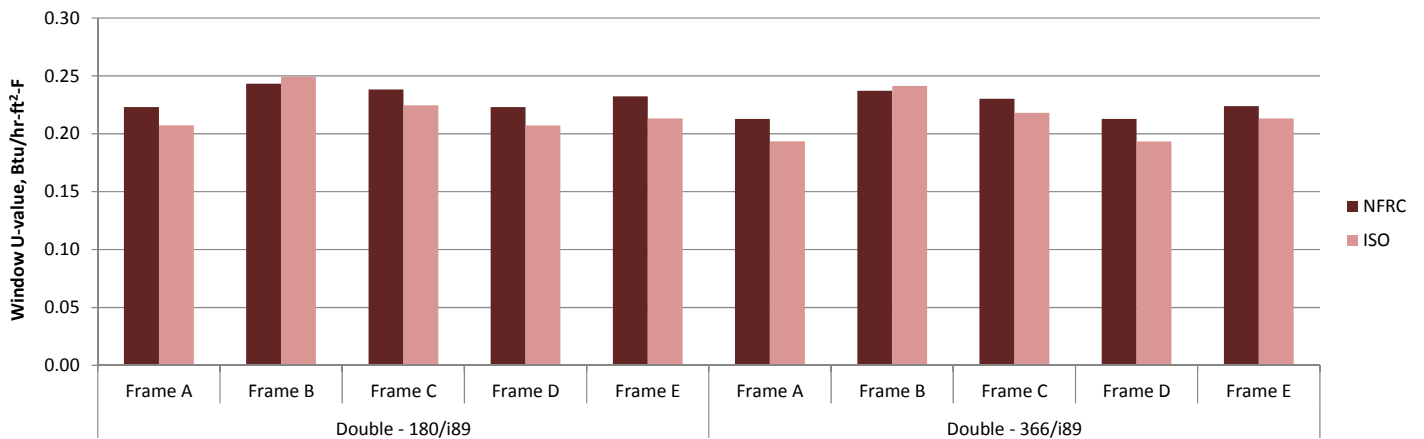

Fig.3.18 Window U-values for fiberglass frame double glazed with surface four low-e coating, Btu/hr-ft²-F.

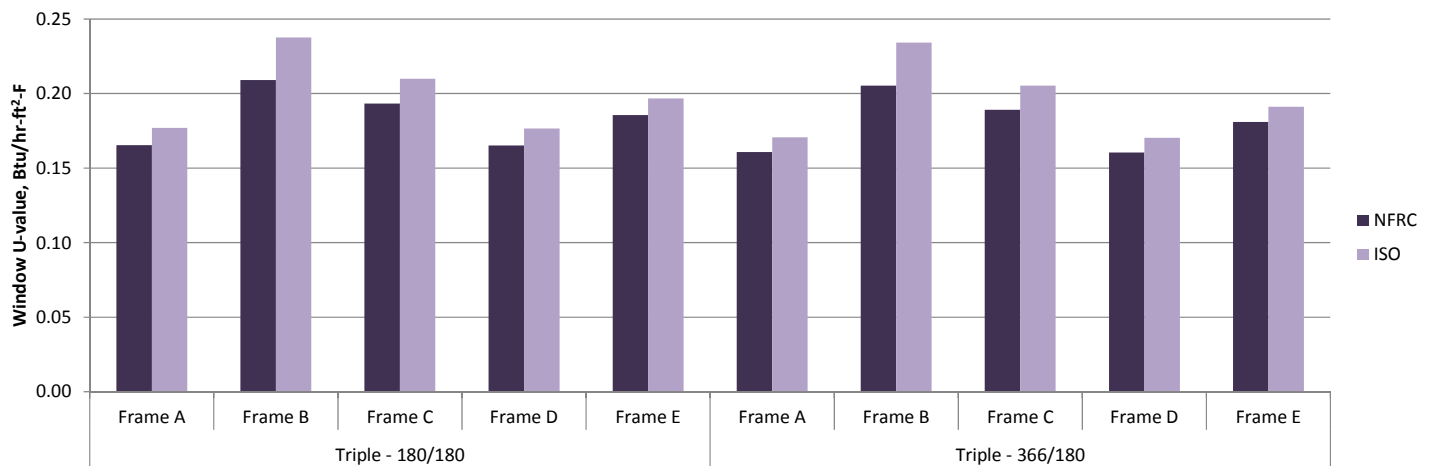

Fig.3.19 Window U-values for fiberglass frame triple glazed with two low-e coatings, Btu/hr-ft²-F.

Table 3.5 Percent difference between NFRC/CSA and ISO whole window U-values; positive indicates higher NFRC/CSA value.

	Frame A	Frame B	Frame C	Frame D	Frame E
Double – 180	14%	1%	8%	14%	8%
Double – 366	15%	0%	9%	15%	9%
Double – 180/i89	7%	-3%	6%	7%	8%
Double – 366/i89	9%	-2%	5%	9%	5%
Triple – 180/180	-7%	-14%	-9%	-7%	-6%
Triple – 366/180	-6%	-14%	-9%	-6%	-6%

### 3.4.5 Solar Heat Gain Coefficient

Table 3.6 and Fig.3.20 show the resulting solar heat gain following NFRC/CSA and ISO calculation procedures. The ISO solar heat gain, or “g-value,” is often reported as centre of glass solar heat gain. The NFRC/CSA and ISO centre of glass values are shown, plus the whole product values for comparison. Note that the NFRC/CSA simulation uses an outdoor temperature of 32°C and incident direct solar radiation of 783 W/m<sup>2</sup>, while the ISO simulation uses an outdoor temperature of 30°C and incident direct solar radiation of 500 W/m<sup>2</sup>.

The centre of glass SHGCs are close between ISO and NFRC/CSA procedures, with 1% difference for the IGUs with LoE-180, and 4% to 7% difference between the IGUs with LoE-366. It was also noted that the interior surface temperature predicted by the software is higher for ISO calculations than for NFRC/CSA calculations. For example, the double glazed LoE-366 window has an interior surface temperature of 28.1°C using NFRC/CSA, and 25.5°C using ISO.

Table 3.6 Solar heat gain calculated following NFRC/CSA and ISO procedures; all whole window values are calculated following NFRC/CSA procedures.

	Centre of Glass Solar Heat Gain			Whole Window NFRC/CSA SHGC				
	NFRC	ISO	% Difference	NFRC Fixed (Picture) (Frame A)	NFRC Casement (Frame B)	Coupled (Frame C)	PHI Fixed (Frame D)	PHI Tilt & Turn (Frame E)
Double – 180	0.66	0.67	-1%	0.53	0.35	0.44	0.54	0.45
Double – 366	0.27	0.28	-4%	0.22	0.15	0.18	0.49	0.41
Double – 180/i89	0.60	0.60	-1%	0.48	0.31	0.40	0.49	0.41
Double – 366/i89	0.27	0.28	-6%	0.22	0.14	0.18	0.22	0.19
Triple – 180/180	0.54	0.55	-1%	0.44	0.28	0.36	0.44	0.37
Triple – 366/180	0.24	0.26	-7%	0.20	0.13	0.16	0.20	0.17

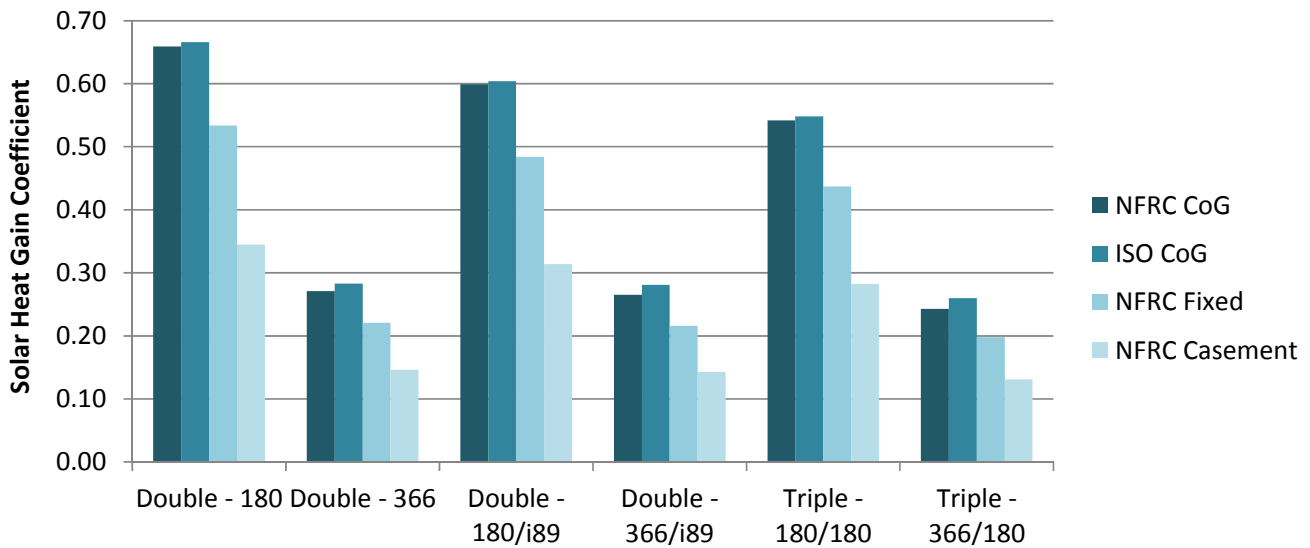

Fig.3.20 Centre of glass and whole product SHGC values.

### 3.5. Window 3 – European Vinyl Frame

The final window simulated is a European vinyl frame. The IGU has 4 mm and a 15.875 mm gap in both the double and triple glazed units. The glazing was simulated in accordance with manufacturers’ drawings. It should be noted that burying the glazing deeper into the frame would change the U-values, however all simulations for this study were completed per the manufacturers drawings. Frames B (casement) and C (coupled) were not simulated for this unit since this series does not have a casement frame.

Two versions of the triple glazed frames were simulated: one typical for Passive House certification with foam insulation in the frame and no metal reinforcing, and one typical of ift Rosenheim certification with reinforcing and limited insulation in the frame (see Fig.3.21). This was done since many European manufacturers are certifying Passive House performance to the ift Rosenheim Guideline WA-15/2 in addition to the PHI standards.

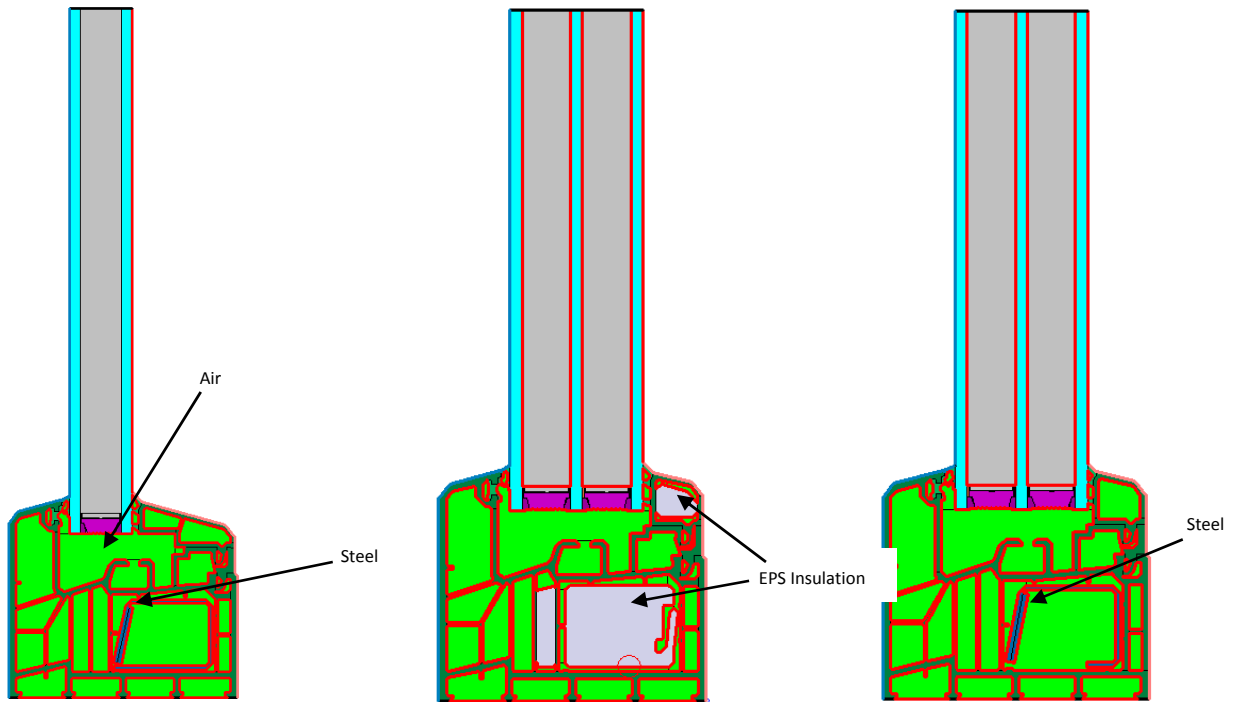

Fig.3.21 THERM simulations of European vinyl frame fixed (picture) sill windows, double glazed (left), triple glazed Passive House certification (centre) and triple glazed Rosenheim certification (right). Note the thick frame (88 mm).

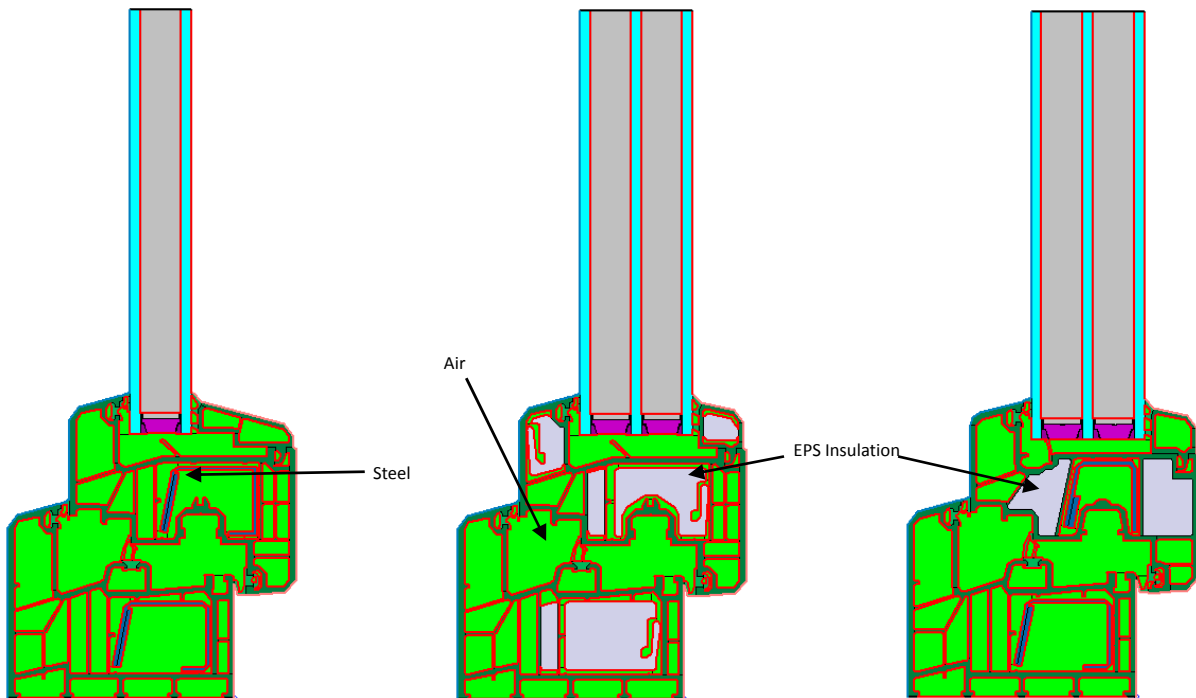

Fig.3.22 THERM simulations of European vinyl frame tilt and turn sill windows, double glazed (left), triple glazed Passive House certification (centre) and triple glazed Rosenheim certification (right). Note the thick frame (112 mm).



### 3.5.2 Centre of Glass U-value

Fig.3.23 shows the centre of glass U-values for each IGU simulated using NFRC/CSA and ISO procedures, and Fig.3.7 shows the percent differences. The NFRC/CSA U-values are highest for each glazing configuration. The results for the triple glazed units are different from the North American glazings, where the U-values from the two procedures were very close. This is because the North American triple glazed units had a gap size of 12.7 mm, which is optimized for NFRC/CSA conditions, while the European triple glazed units have a gap size of 15.875 mm, which is better for ISO conditions (see Fig.3.3).

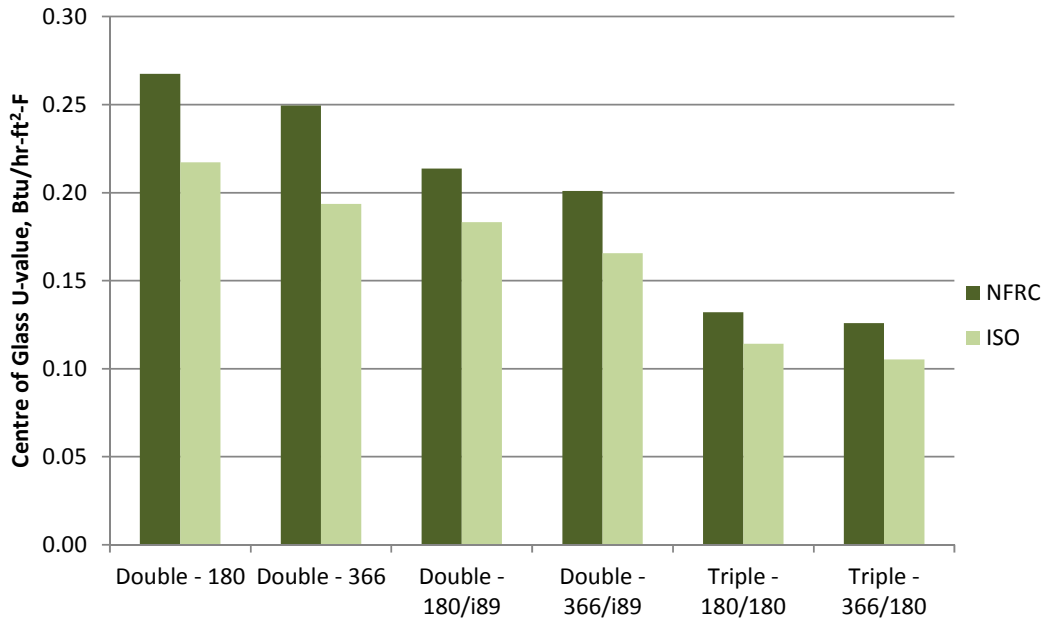

Fig.3.23 Centre of glass U-value simulated using NFRC/CSA, ISO and PHI procedures.

Table 3.7 Percent difference between NFRC/CSA and ISO centre of glass U-values.

	Percent Difference between NFRC/CSA and ISO (positive indicates higher NFRC/CSA)
Double – 180	19%
Double – 366	22%
Double – 180/i89	14%
Double – 366/i89	18%
Triple – 180/180	14%
Triple – 366/180	17%

### 3.5.3 Frame U-values

Fig.3.24, Fig.3.25, Fig.3.26 and Fig.3.27 show the frame U-values for the fixed (picture) window frame components simulated using NFRC/CSA and ISO conditions. Results for the tilt and turn components are similar.

The NFRC/CSA values are higher than the ISO values. This is because the NFRC/CSA frame U-value is simulated with the actual IGU, whereas the ISO frame U-value is simulated with a calibration panel with a lower thermal conductivity than the IGU, creating

a better (lower) U-value for ISO conditions (as with the other windows that were simulated). Also note the low scale in the plots for the Passive House certified triple glazed unit, showing low U-values for these frame components (Fig.3.26).

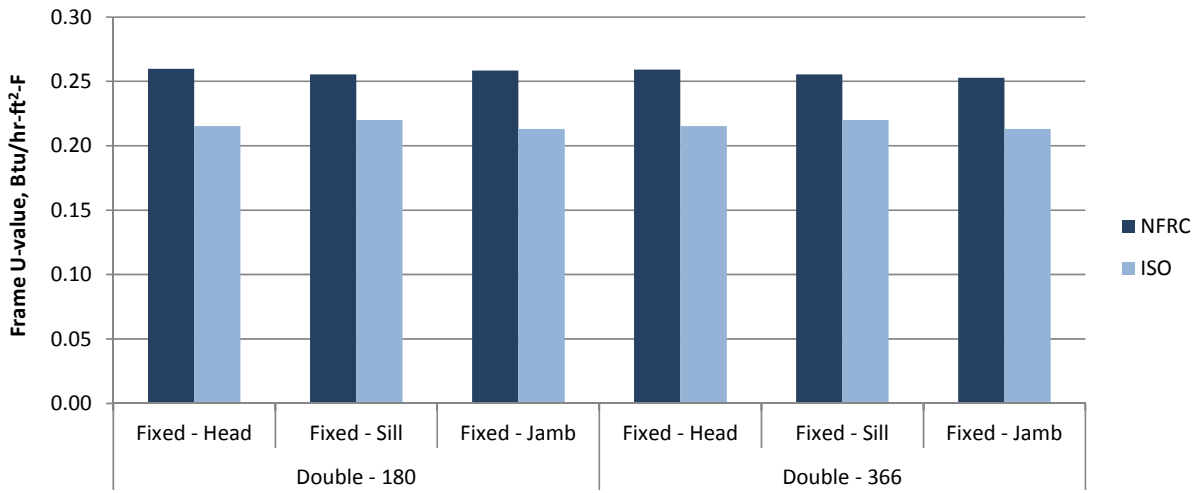

Fig.3.24 Frame U-value simulated using NFRC/CSA and ISO procedures for the fixed (picture) frame components.

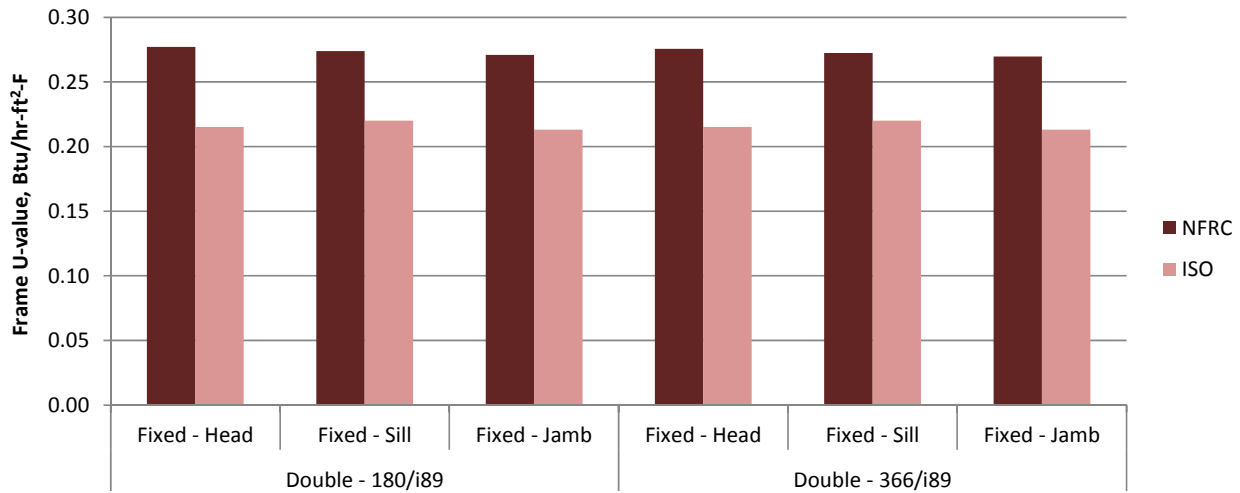

Fig.3.25 Frame U-value simulated using NFRC/CSA, ISO and PHI procedures for the fixed (picture) frame components.

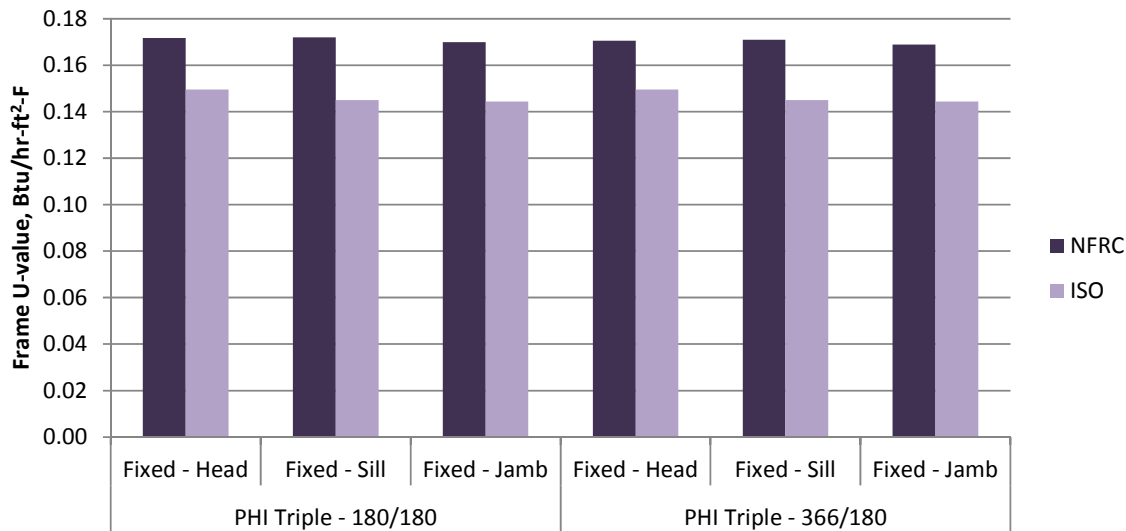

Fig.3.26 Frame U-value simulated using NFRC/CSA and ISO procedures for the fixed (picture) frame components (note different scale than double glazed).

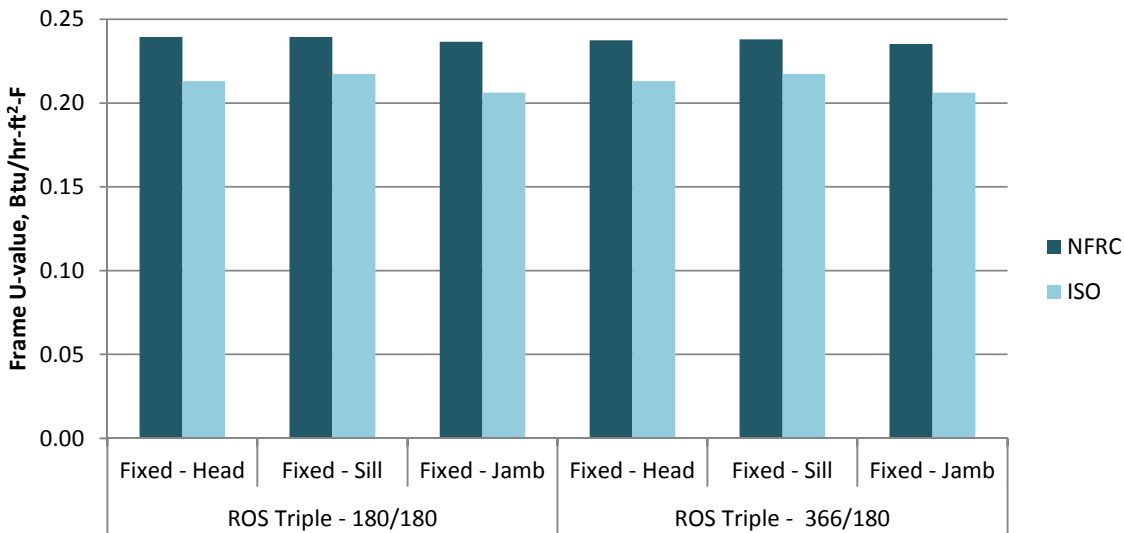

Fig.3.27 Frame U-value simulated using NFRC/CSA and ISO procedures for the fixed (picture) frame components.

A comparison of edge of glass values is not shown, since the ISO whole window calculations use a linear transmittance ( $\Psi$ ) value, calculated from the actual IGU simulation and a calibration panel simulation. The NFRC/CSA edge of glass value uses only the actual IGU, and does not use a calibration panel. For this study, an ISO spreadsheet (provided by LBNL) was used to calculate the  $\Psi$ -value and the overall ISO window U-value from the THERM and WINDOW simulation results for the IGU and calibration panel simulations (specifically, the U-values and projected frame dimensions). However, there is no true comparison between NFRC/CSA and ISO edge of glass values since the two methods use different simulations and calculations.

### 3.5.4 Whole Product U-value

The whole window U-value simulation results for the vinyl frame double and triple glazed windows are shown in Fig.3.28, Fig.3.29, Fig.3.30 and Fig.3.31. Table 3.8 shows the percent difference between the NFRC/CSA and ISO simulated U-values. For all windows, the NFRC/CSA U-values are consistently higher than the ISO U-values, with percent differences ranging from 9% to 13%. Also note

the difference between the Passive House (PHI) and Rosenheim (ROS) qualified triple glazed window products; using the ISO simulation methodology, the PHI product results in lower U-values (Fig.3.30 and Fig.3.31).

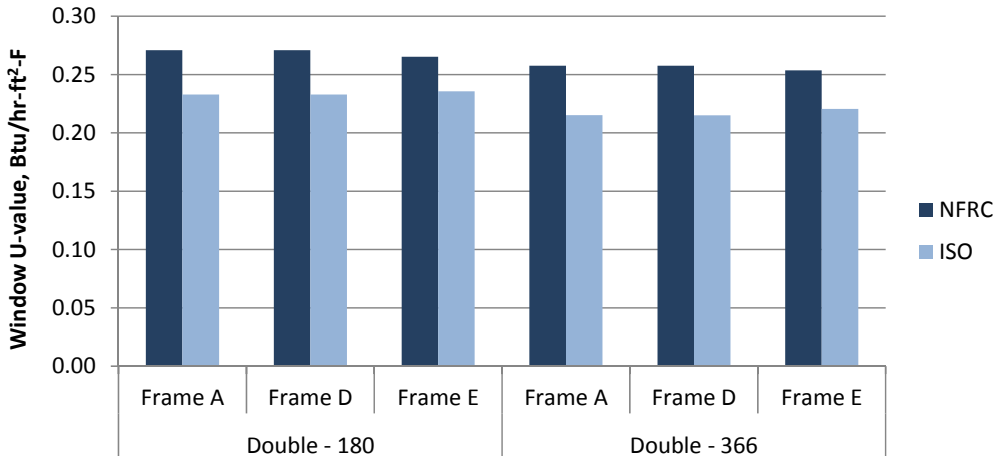

Fig.3.28 Window U-values for vinyl frame double glazed with one low-e coating, Btu/hr-ft²-F.

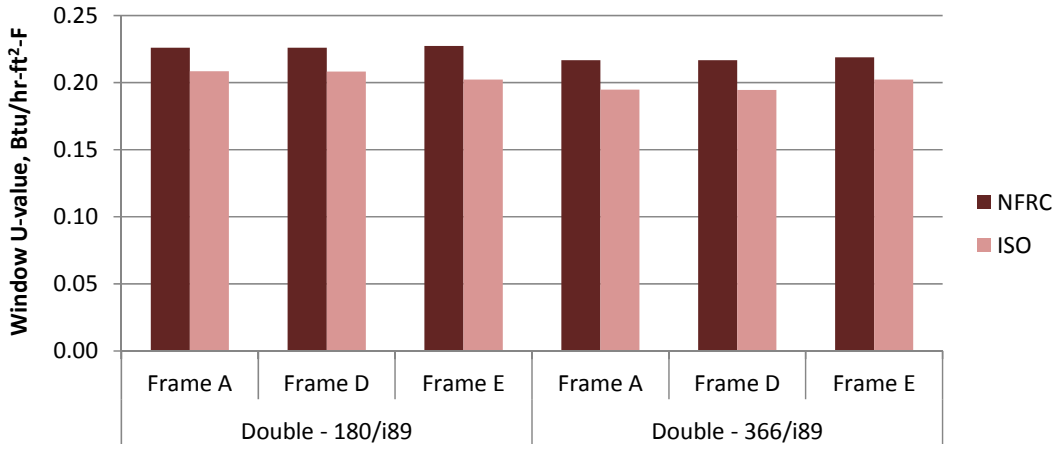

Fig.3.29 Window U-values for vinyl frame double glazed with surface four low-e coating, Btu/hr-ft²-F.

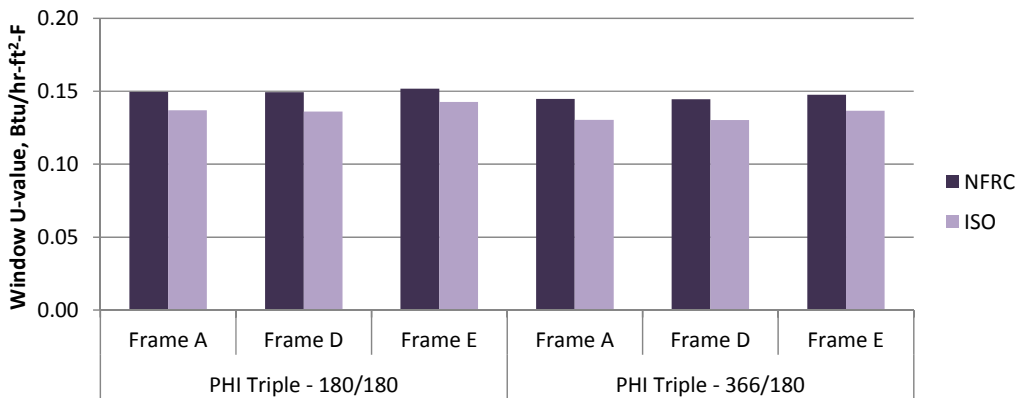

Fig.3.30 Window U-values for vinyl frame triple glazed with two low-e coatings, Btu/hr-ft²-F.

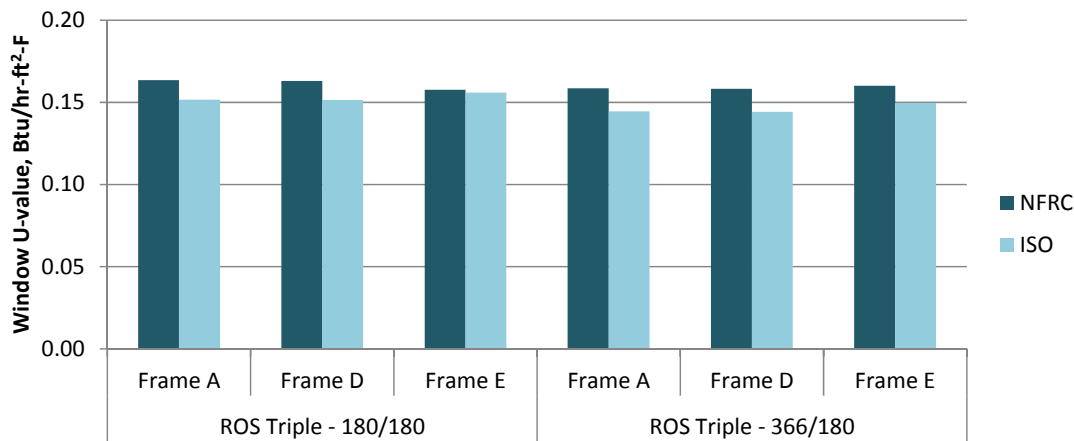

Fig.3.31 Window U-values for vinyl frame triple glazed with two low-e coatings, Btu/hr-ft<sup>2</sup>-F.

Table 3.8 Percent difference between NFRC/CSA and ISO whole window U-values; positive indicates higher NFRC/CSA U-value.

	Frame A	Frame D	Frame E
Double – 180	13%	12%	13%
Double – 366	17%	13%	17%
Double – 180/i89	9%	7%	9%
Double – 366/i89	11%	8%	11%
Triple – 180/180	10%	6%	10%
Triple – 366/180	11%	8%	11%

### 3.5.5 Solar Heat Gain Coefficient

Table 3.9 and Fig.3.32 show the resulting solar heat gain coefficients following NFRC/CSA and ISO calculation procedures. The ISO solar heat gain, or “g-value,” is often reported as centre of glass solar heat gain. The NFRC/CSA and ISO centre of glass values are shown, plus the whole product values for comparison. Note that the NFRC/CSA simulation uses an outdoor temperature of 32°C and incident direct solar radiation of 783 W/m<sup>2</sup>, while the ISO simulation uses an outdoor temperature of 30°C and incident direct solar radiation of 500 W/m<sup>2</sup>.

The centre of glass SHGCs are close between ISO and NFRC/CSA procedures, with 1% difference for the IGUs with LoE-180, and 5% to 7% difference between the IGUs with LoE-366. The results show a greater difference between the two procedures for the lower solar heat gain IGU. It was also noted that the interior surface temperature predicted by the software is higher for ISO calculations than for NFRC/CSA calculations. For example, the double glazed LoE-366 window has an interior surface temperature of 28.1°C using NFRC/CSA, and 25.7°C using ISO.

Table 3.9 Solar heat gain calculated per NFRC/CSA and ISO procedures; whole window values calculated per NFRC/CSA.

	Centre of Glass Solar Heat Gain			Whole Window NFRC/CSA SHGC	
	NFRC	ISO	% Difference	NFRC Fixed (Picture) (Frame A)	Tilt & Turn (Frame E)
Double – 180	0.67	0.68	-1%	0.53	0.46
Double – 366	0.27	0.29	-5%	0.22	0.19
Double – 180/i89	0.61	0.61	-1%	0.49	0.42
Double – 366/i89	0.27	0.28	-6%	0.22	0.19
Triple – 180/180	0.54	0.55	-1%	0.42	0.37

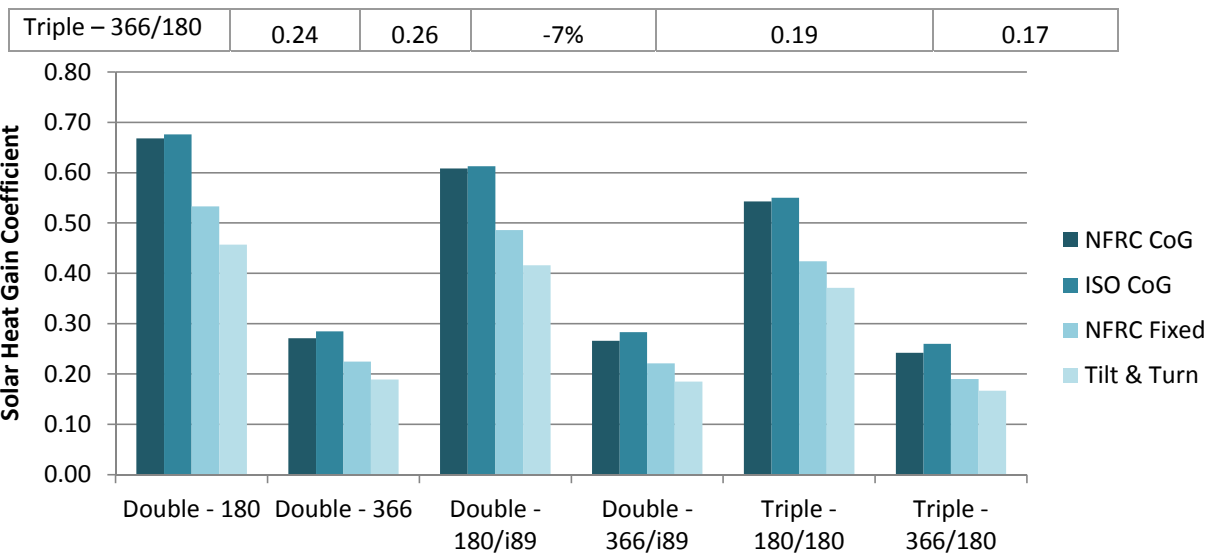

Fig.3.32 Centre of glass and whole product SHGC values.

### 3.6. Relationship between NFRC/CSA and ISO U-values

The simulation results for the three windows were plotted to assess whether a relationship exists between NFRC/CSA and ISO U-values. Due to the complex nature of the differences between the calculation procedures, a clear correlation or “conversion factor” is not anticipated to exist. However, the relationships can be explored by plotting the values. This section shows plots for the North American fiberglass window; plots for the North American vinyl and European vinyl windows are similar.

Fig.3.33, Fig.3.34 and Fig.3.35 show the following plots of ISO vs. NFRC/CSA U-value: centre of glass, frame, and whole window. The centre of glass values appear to have a near linear relationship, with  $R^2$  error values of 0.98 for the ISO vs. NFRC/CSA relationship (see Fig.3.3). However, note that this is for one gap size, and the plot of U-value versus gap size is not linear.

The relationship between the frame and edge of glass U-values is inconsistent. The whole window U-values show a near linear relationship, with  $R^2$  error values from 0.91 to 0.98. However, it is noted that in all of these plots, even where a good  $R^2$  value exists, the equation for the trend line is different for various frame sizes. The relationships are similar for the other frames, though also with different linear equations.

Fig.3.36 shows a plot of ISO vs. NFRC/CSA centre of glass solar heat gain. The results show a linear relationship, with the slope very close to 1; this reflects the small difference between the NFRC/CSA and ISO solar heat gain results for the IGUs that were simulated.

Based on these findings, a standard correlation is not recommended for converting between NFRC/CSA and ISO values.

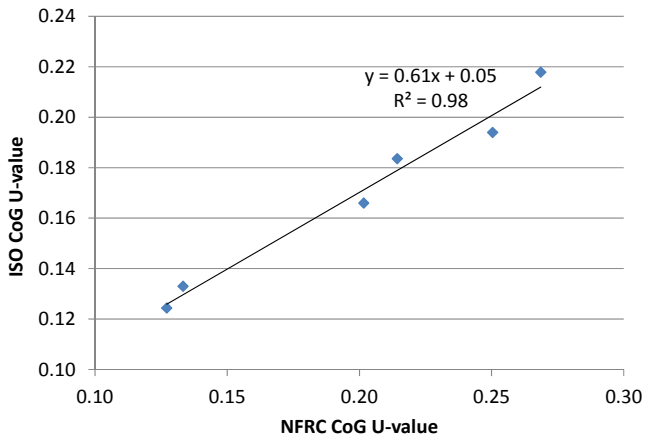

Fig.3.33 Centre of glass U-value relationship between ISO vs. NFRC/CSA for IGUs that were modeled.

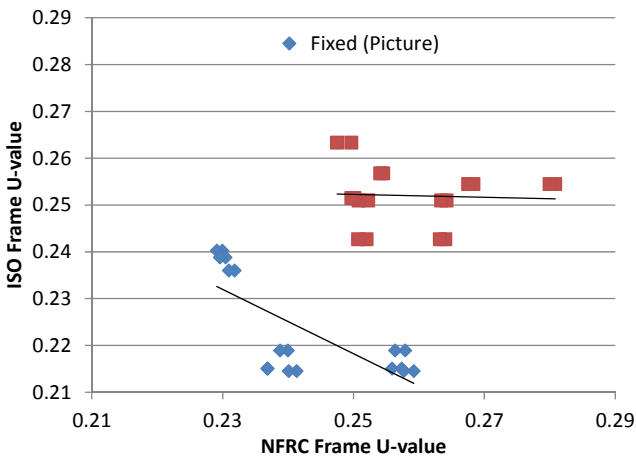

Fig.3.34 Frame U-value relationship between ISO vs. NFRC/CSA.

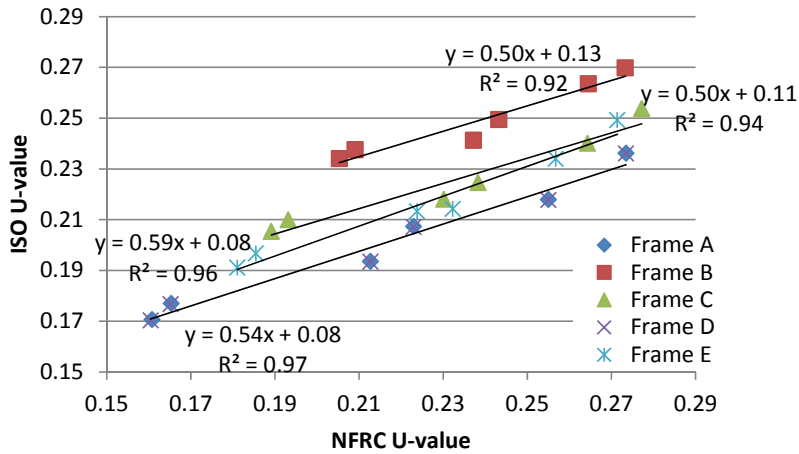

Fig.3.35 Whole window U-value relationship between ISO vs. NFRC/CSA.

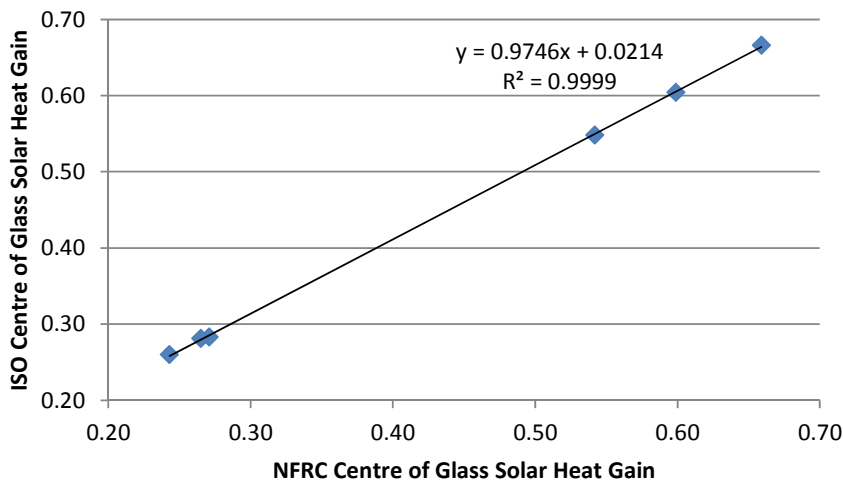

Fig.3.36 Centre of glass SHGC relationship between ISO vs. NFRC/CSA.

### 3.7. Summary

The NFRC/CSA and ISO simulation results help to quantify the differences between procedures, and identify the more significant factors that result in discrepancies.

The centre of glass U-values differed by 14% to 23% between NFRC/CSA and ISO values for IGUs with a 15.875 mm gap space, while the units with a 12.7 mm gap space varied by 0% to 2%.

The different temperature boundary conditions appear to have greater effect on the centre of glass U-value than on the frame U-value, since frame U-values were closer between NFRC/CSA and ISO procedures. The different material properties used for standard materials in the two procedures (i.e. materials that do not have a rated conductivity) also affect the resulting U-value. The frame cavity conductivity is higher for NFRC/CSA than for ISO (NFRC  $k = 0.5804$  W/m-K compared to  $k = 0.4298$  W/m-K for ISO). The main material difference noted was that of fiberglass, which has a conductivity of  $0.30$  W/m-K for NFRC/CSA procedures, compared to  $0.40$  W/m-K for ISO procedures. Frame U-values for the ISO simulations are completed using a calibration panel, while the NFRC/CSA frame U-values use the actual glazing unit.

Differences in solar heat gain ratings were also noted, due to the higher incident solar radiation used in NFRC/CSA. Up to 7% difference in the centre of glass solar heat gain coefficient was noted. It is also important to recognize the difference between centre of glass solar heat gain properties, which are often used for the European 'g-value', versus whole product solar heat gain, which is typically used for the NFRC/CSA Solar Heat Gain Coefficient (SHGC).

Fig.3.37 shows a comparison between NFRC/CSA and ISO window U-values for the three windows simulated in double and triple glazing. Overall, whole window U-values differed by up to 17% between NFRC/CSA and ISO calculated values in the windows simulated in this study. The differences noted above all contribute to the variation in window U-values, as well as other calculation differences such as the difference in edge of glass calculations, and the difference in IGU gap calculations. Care must be taken to use and reference correct U-values ( $U_{NFRC}$  or  $U_{ISO}$ ) when comparing window options and performing energy simulations.



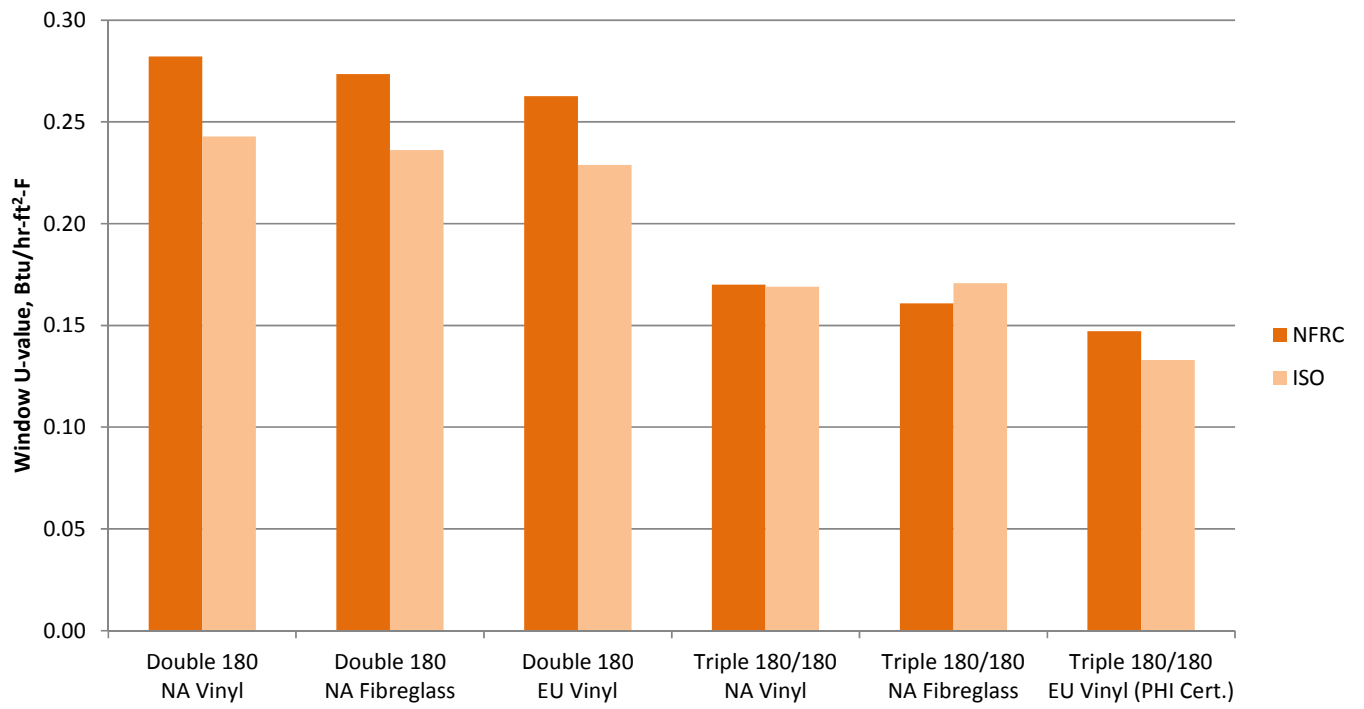

Fig.3.37 Plots of whole window U-value versus gap size for NFRC/CSA and ISO procedures.

## 4. Conclusions

This report presents a literature review and simulation results to understand the differences between North American, European, and Passive House window thermal performance rating standards. Differences between window ratings systems can create challenges in qualifying North American fenestration products for Passive House buildings, and in qualifying European products for use in North American jurisdictions. This study seeks to identify and quantify differences between the rating systems, in order to provide a better understanding of fenestration ratings for designers and specifiers.

### 4.1. Primary Differences Between Standards

The literature review included North American, European (ISO, EN and British), and Passive House standards related to window thermal performance ratings. In North America, windows are certified using NFRC/CSA standards. In Europe, windows are certified using ISO and EN standards. Passive House also requires ISO certification, though the Passive House window certification program has one key difference: the exterior temperature is simulated at climate-specific outdoor temperatures rather than the ISO standard 0°C (though the ISO standard 0°C is acceptable for the cold-temperate climate). Note that these boundary conditions are only for Passive House certified windows, and the requirements for Passive House certified buildings do not require the windows to be Passive House certified. It is not clear which outdoor boundary condition is to be used for window inputs into the PHPP software program.

Although there are many differences between the NFRC/CSA, ISO and PHI standards, the primary differences are as follows:

- ..... Different boundary conditions: NFRC/CSA, ISO and PHI use different temperatures, surface films, and incident solar radiation (for solar heat gain calculations). These values are shown for the key standards in Table 4.1 and Table 4.2.
- ..... Differences in calculating solar heat gain: There are two primary differences in the North American and European solar heat gain calculations. First, the NFRC/CSA Solar Heat Gain Coefficient (SHGC) is for the whole window product. On the other hand, the Passive House simulation software requires a centre of glass solar heat gain value, called the “g-value.” In the standards for g-value calculation, this value can be determined for either the whole window or the centre of glass; however, it is commonly reported as a centre of glass value for Passive House windows. This is an important difference to recognize, since centre of glass values are higher than whole window values since the opaque frame area reduces solar heat gain in a whole window calculation. The second difference in solar heat gain calculations is the different boundary conditions, including different temperatures and incident solar radiation.
- ..... Different calculation of centre of glass heat transfer: The ISO method uses a simplified calculation procedure with an assumed mean temperature difference across the gas space. The NFRC/CSA method references a different ISO standard, which uses a more comprehensive calculation procedure based on heat transfer relationships solved using numerical methods.
- ..... Different methods of accounting for edge of glass effects: The NFRC/CSA procedure determines an edge of glass U-value for the glazing, frame and spacer configuration measured 63.5 mm (2.5 inches) from the frame sight line. The ISO procedure uses a linear thermal transmittance or  $\Psi$ -value to account for this heat transfer, which is calculated by comparing simulations with the specific IGU and spacer to simulations with a calibration panel with a specified conductivity inserted into the frame in place of an IGU.
- ..... Different frame simulations: Using the NFRC/CSA procedure, the frame U-value is simulated with the actual IGU in place. Using the ISO procedure, the frame U-value is simulated with a calibration panel with a specified conductivity of  $k = 0.035$  W/m-K for the thickness of the manufacturers standard IGU width.
- ..... Different reference sizes: The standard sizes for NFRC/CSA and European windows are slightly different. For a fixed window, the NFRC/CSA size is 1.2 m x 1.5 m, and the Passive House size is 1.23 m by 1.48 m. NFRC/CSA provides standard sizes for different types of windows (e.g. casements have a standard size of 1.5 m x 0.6 m). Passive House does not, however when

windows are modeled in the Passive House software, actual project sizes and component properties (centre of glass, frame, edge) are used. The ISO standards themselves do not provide standard window sizes, however other European rating organizations do have standard sizes. For example, the British Fenestration Rating Council (BFRC) standard size is a coupled window with one opening lite, one fixed lite and a central divider.

- ..... Differences in treatment of sloped glazing: Following NFRC/CSA procedures, skylights and other sloped glazing are simulated at an angle of 20° above the horizontal. Following ISO standards, parameters are calculated in a vertical position for the purpose of comparing different products. Passive House certification criteria state that roof windows are to be modeled at a 45° inclination. These differences are significant as it affects the calculated U-value (slope reduces the glazing thermal performance significantly), however this was not assessed further through simulations in this study.
- ..... Installation  $\Psi$ -values: Passive House is the only standard evaluated in this study that incorporates the thermal performance of the window installation, via an installation  $\Psi$ -value (perimeter linear transmittance). Although not part of the rated window U-value, the installation  $\Psi$ -value is used in the Passive House modeling software (PHPP).

Table 4.1 Exterior and interior surfaces temperatures for U-value and SHGC calculations.

	U-value		Solar Heat Gain		
	Exterior Temperature	Interior Temperature	Exterior Temperature	Interior Temperature	Solar Radiation
NFRC 100 & 200	-18°C	21°C	32°C	24°C	783 W/m <sup>2</sup>
ISO 10077-1, ISO 10077-2 and ISO 15099	0°C	20°C	30°C	25°C	500 W/m <sup>2</sup>
Passive House Certification Criteria	Frame: -10°C Glazing: 20°C to -7°C (climate dependant)	20°C	30°C	25°C	500 W/m <sup>2</sup>

Table 4.2 Standard surface film coefficients for U-value calculations, vertical glazing.

	Exterior, W/m <sup>2</sup> -K	Interior, W/m <sup>2</sup> -K	Notes
NFRC 100 Interior Aluminum Frame Interior Thermally Broken Frame Interior Thermally Improved Frame Interior Wood/Vinyl frame (frame and edge of glass simulations)	26.0	3.29 3.00 3.12 2.44	Radiation model is an automatic enclosure model for interior frame surfaces, blackbody for exterior surfaces. (interior coefficients are convection only) Glazing system boundary conditions depend on the WINDOW calculations for the imported glazing system (e.g. automatically adjusts coefficient for glazing with a surface 4 low-e coating).
ISO 10077-1, ISO 10077-2 and EN 673	25	7.7	Interior coefficient is combined convection and radiation. Reduced radiation/convection boundary conditions are applied to the indoor side where there are facing segments at corners. For glazing, interior coefficient depends on emissivity (e.g. coefficient varies for glazing with a surface 4 low-e coating).
Passive House	25	7.7	Combined convection and radiation coefficient, same as ISO/EN.

## 4.2. Impact on Thermal Performance Values

The differences between the ISO and NFRC/CSA calculation methods are numerous and complex, and therefore identifying how each factor quantitatively impacts U-value and SHGC calculations is difficult and beyond the scope of this report. However, the simulations performed can be used to draw general guidelines as to how great (or small) the differences between methodologies can be.

- Centre of glass U-values in this study showed NFRC/CSA values were between zero and 23% higher (worse) than ISO values. Smaller gap sizes optimized for NFRC/CSA (e.g. 12.7 mm) resulted in small difference (0% to 2%) between the two standards. Larger gap sizes (e.g. 15.875 mm) resulted in greater differences (14% to 23%).

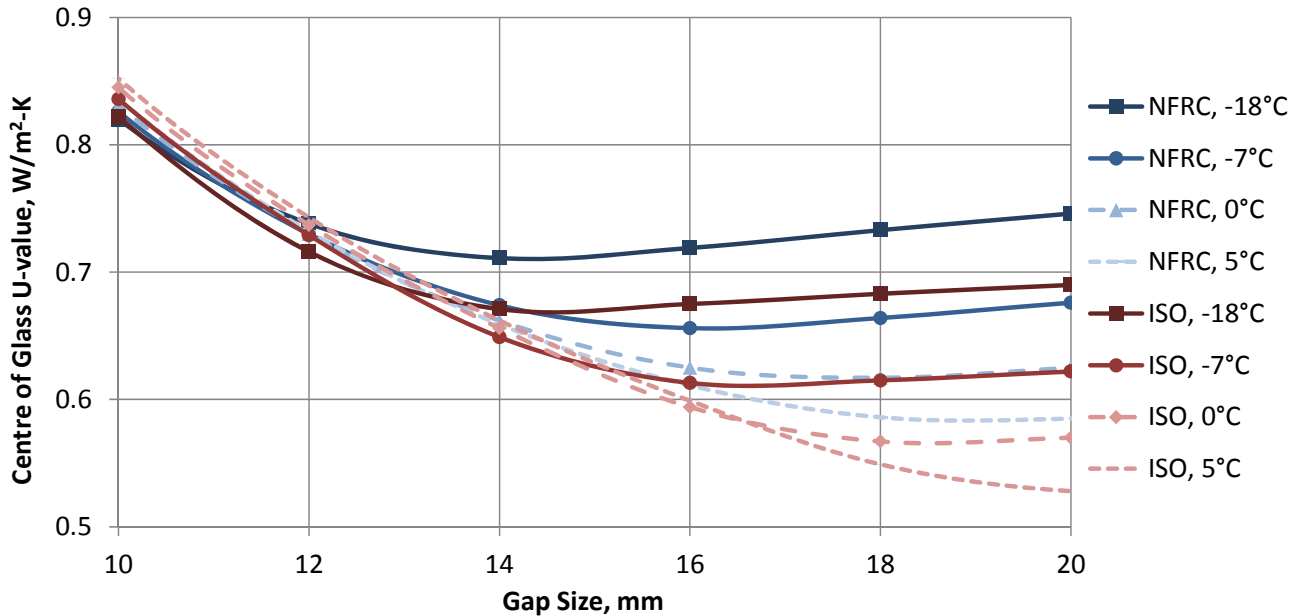

Fig.4.1 Plots of centre of glass U-value versus gap size for NFRC/CSA and ISO procedures using different exterior boundary conditions.

- Frame U-values in this study showed NFRC/CSA values were between 5% lower to 24% higher compared to ISO values. The smaller percent differences occurred in the case of the fiberglass frame window, which used a lower conductivity for fiberglass in the NFRC/CSA simulations, which offset some of the difference due to the calibration panel.
- The NFRC/CSA edge of glass U-value is based on the THERM simulation of the frame, spacer and IGU. In contrast, the ISO edge of glass  $\Psi$ -value is based on a linear transmittance, calculated from the simulations both with a glazing unit and with a calibration panel. Therefore there is no true comparison between NFRC/CSA and ISO edge of glass values, as the NFRC/CSA method does not involve a calibration panel.
- Whole window U-values in this study showed NFRC/CSA values were between 14% lower to 18% higher than ISO values. The lower NFRC/CSA U-values occurred with the 12.7 mm gap size in the North American vinyl and fiberglass frames, and also with 15.875 mm gaps in the fiberglass frame casement (as the large gap size results in higher ISO values).
- Solar heat gain values for the centre of glass were between 1% and 8% lower using NFRC/CSA compared to ISO procedures. The greater differences resulted for the low solar heat gain glazing. Whole window solar heat gain values are up to 50% lower than centre of glass values.

## 4.3. Considerations for Designers and Specifiers

Several important considerations in selecting windows can be drawn from this study. Firstly, it is important to be aware that NFRC/CSA, ISO, and Passive House U-values cannot be compared as they are based on different calculation procedures. For example, when comparing a product from Europe and a product from North America, designers should ask for the values in one

or the other standard. Going forward, it may be useful for the industry to add subscripts for NFRC/CSA and ISO U-values to prevent comparing values from different systems (i.e.  $U_{NFRC}$ ,  $U_{ISO}$ ). Also, when comparing Passive House certified results, a variety of different boundary conditions may have been used in the simulations.

When designers are looking for windows for a Passive House certified building, many North American products currently will not match European performance values even when calculated using the same standards due to different product design, particularly different IGU gap sizes. Gap sizes in North America have been optimized to yield the best NFRC/CSA U-values, and when the same product is modeled using ISO or PHI standards it will not perform as well as a product with larger gap sizes.

It is also important for designers to be aware of different solar heat gain metrics. Passive House solar heat gain values and “g-values” typically refer to a centre of glass value, whereas the NFRC/CSA Solar Heat Gain Coefficient (SHGC) that is typically reported for North American products is for the whole window. This study showed whole window values can be up to 50% lower than centre of glass values. Further, even when comparing centre of glass values from NFRC/CSA and ISO or PHI windows, there are additional differences, and so these values are also not an ‘apples to apples’ comparison. For example, Passive House recommends glazing with solar heat gain greater than 0.5; an NFRC/CSA centre of glass value of 0.45 might achieve this (depending on the glazing), and an overall NFRC/CSA SHGC of 0.35 may also meet this requirement (depending on the frame and glazing).

The Passive House certification criteria are different for Passive House buildings and for Passive House components, including windows. Passive House buildings are not required to use Passive House certified windows (though it helps to make the building certification process easier). The criteria for windows and window component maximum U-values are from the window certification criteria, and not the building certification criteria. Also, some of the criteria result from hygiene (i.e. condensation) requirements and thermal comfort requirements rather than energy targets. For Passive House certified window products, window certification criteria is climate dependant, and colder cities have more stringent requirements (Certification Criteria for Certified Passive House Glazings and Transparent Components, Passive House Institute, June 2012).

Finally, certified U-values are often used for selecting windows and analyzing energy consumption of a building, however each of the certification programs (NFRC/CSA, ISO and Passive House) have strengths and weaknesses, and neither may facilitate optimal window selection for a particular building. Window frame U-values vary with temperature and surface air films, and therefore vary for different climates. NFRC/CSA windows are modeled at an outdoor temperature of  $-18^{\circ}\text{C}$ , which is not representative of average winter temperatures in many North American locations, and is also colder than the winter design temperature in many locations. This value is less accurate to use for annual energy modeling and predictions, as well as optimal design, in many locations. However, this value is more appropriate for peak design and sizing calculations as it provides a worst case temperature for many locations. On the contrary, the ISO outdoor temperature of  $0^{\circ}\text{C}$ , and the Passive House climate specific outdoor temperatures, may be more accurate for annual energy calculations, but less accurate for peak heating and sizing calculations. Higher outdoor temperatures result in better (lower) window U-values. There is no easy solution to this issue as consistent conditions are needed for rating and comparing products, but it is useful for designers to be aware that the optimal window for a particular climate may not be indicated by certification U-values from a particular rating system.

#### **4.4. Considerations for Manufacturers and Product Design**

All of the challenges discussed for designers and specifiers are also important for manufacturers to be aware of when talking to clients or potential clients. Manufacturers may want to consider labeling U-values as either  $U_{NFRC}$  or  $U_{ISO}$  to avoid confusion of comparing values calculated under different standards.

The study also identified some important considerations related to product design. North American window manufacturers currently need to have their products rated to ISO or Passive House standards for use in certified Passive House buildings. However, the resulting U-values may still not be as low as products from European manufacturers due to smaller IGU gap sizes that are optimized for NFRC/CSA conditions. Because of this, North American manufacturers may want to design frames with an

allowance for the incorporation of large IGU depths within existing or new window frame profiles (many window frame profiles originally developed for double glazing have already been modified for North American triple glazing (12.7 mm spacers) and do not have room for larger 16 to 18 mm gap widths). However, this may not result in the best window design for a particular project and climate, as the optimal gap size and other factors depend on specific climate conditions.

Argon gas fill is standard in both North America and Europe, and European technology has demonstrated that the use of more expensive inert gases such as Krypton or Xenon is not necessary for Passive House qualified windows.

#### **4.5. Future Work**

This project provided an initial review of the different window certification standards. The work also identified many additional areas for research and development work. The following are areas for future work:

- ..... Further research into climate-specific U-values, and the optimal product design for particular climate, should be completed. For example, it may be possible to report temperature-dependent U-values determined from simulations, which could be entered into whole building energy modeling software to more accurately simulate the window and chose the best product. This could be similar to the angle-dependent solar optical properties of glass, which are currently dealt with by inputting angle-dependent solar heat gain values into energy modeling software to more accurately calculate solar heat gain.
- ..... Investigate the standardization of subscripts on U-values and solar heat gain values (SHGC or g-values) to clearly identify for which standard the U-value has been certified.
- ..... Simulations should be completed to investigate the difference in U-values for sloped glazing calculated using the NFRC/CSA, ISO and PHI procedures.
- ..... Educate the window manufacturing and the design community on the differences between North American and European U-values and solar heat gain factors.

# **Appendix A**

## **Literature Review Summary Sheets**

- R1 Canadian Standards Association. (2009). *CSA A440.2-09 Fenestration energy performance*. Mississauga.
- R2 National Fenestration Rating Council (NFRC). (2010). *NFRC 100-2010 Procedure for Determining Fenestration Product U-factors*. Greenbelt.
- R3 National Fenestration Rating Council (NFRC). (2010). *NFRC 200-2010 Procedure for Determining Fenestration Product Solar Heat Gain Coefficient and Visible Transmittance at Normal Incidence*. Greenbelt.
- R4 Lawrence Berkeley National Laboratory. (2010). *THERM6 and WINDOW6*. Berkeley.
- R5 Lawrence Berkeley National Laboratory. (2003). *THERM 5 / WINDOW 5 NFRC Simulation Manual*. Berkeley.
- R6 International Organization for Standardization (ISO). (2009). *ISO 10077-1:2006 Thermal performance of windows, doors and shutters – Calculation of thermal transmittance – Part 1: General*. Geneva.
- R7 International Organization for Standardization (ISO). (2009). *ISO 10077-2:2006 Thermal performance of windows, doors and shutters – Calculation of thermal transmittance – Part 2: Numerical method for frames*. Geneva.
- R8 International Organization for Standardization (ISO). (2003). *ISO 15099:2003 Thermal performance of windows, doors and shading devices – Detailed calculations*. Geneva.
- R9 British Standards Institute (BSI). (2011). *BSI EN 673:2011 Glass in building – Determination of thermal transmittance (U value) – Calculation method*. London.
- R10 International Organization for Standardization (ISO). (1994). *ISO 10292 Glass in building – Calculation of steady-state U values (thermal transmittance) of multiple glazing*. Geneva.
- R11 International Organization for Standardization (ISO). (2007). *ISO 10211 Thermal bridges in building construction – Heat flows and surface temperatures – Detailed calculations*. Geneva.
- R12 International Organization for Standardization (ISO). (2011). *ISO 18292 Energy performance of fenestration systems for residential buildings - Calculation procedure*. Geneva.
- R13 British Standards Institute (BSI). (2011). *BSI EN 410:2011 Glass in building – Determination of luminous and solar characteristics of glazing*. London.
- R14 HM Government. (2010). *L1A Conservation of fuel and power in new dwellings*. London.  
HM Government. (2010). *L2A Conservation of fuel and power in new buildings other than dwellings*. London.
- R15 BRE. (2006). *BR 443 Conventions for U-value calculations*. Watford.
- R16 Passivhaus Institut. (2007). *Passive House Planning Package (PHPP) Version 1.0*. Darmstadt.
- R17 Passivhaus Institut. (2012). *Certification Criteria for Certified Passive House Glazings and Transparent Components*. Darmstadt.
- R18 Wright, G. (2012). *Calculating Window Performance Parameters for Passive House Energy Modeling*. Passive House Institute US (PHIUS): Urbana.
- R19 ift Rosenheim. (2012). *Directive WA-15/2 Suitability of windows, exterior doors and curtain walling for passive houses*. Rosenheim.



**R1 Document Information**

..... Canadian Standards Association. (2009). *CSA A440.2-09 Fenestration energy performance*. Mississauga.

**Summary**

This standard specifies the determination of energy performance properties including U-value, SHGC, and VT for fenestration products. The standard also includes the calculation for the Energy Rating (ER) for windows in low-rise residential buildings.

**Key Points**

- ..... Applies to fenestration systems covered by A440, including vertically sliding windows, horizontally sliding windows, dual-action windows, casement windows, projecting windows, fixed windows, sidelites, transom windows, sliding glass doors, side-hinged doors, dual-action side-hinged doors, architectural terrace doors, unit skylights and roof windows, greenhouse or garden windows, tubular daylighting devices, and curtain walls.
- ..... Gives standard sizes for various fenestration types (see Fig. A1.1 below).
- ..... Unit skylights and roof windows are evaluated at a slope of 20° from the horizontal. Tubular daylighting devices are evaluated with the tube in a vertical orientation. All other fenestration systems are evaluated in the vertical position.
- ..... Overall coefficient of heat transfer (U-value) can be determined by measurement or by computer simulation. By measurement, U-value is determined in accordance with NFRC 102. By computer simulation, U-value is determined in accordance with NFRC 100.
- ..... SHGC can be determined by measurement or by computer simulation. By measurement, SHGC is determined in accordance with NFRC 201 or CANMET’s “The determination of fenestration Solar Heat Gain Coefficient using simulated solar irradiance, part 1.” By computer simulation, SHGC is determined in accordance with NFRC 200.
- ..... Visible Transmittance (VT) can be determined by measurement (ASTM E 1175) or by computer simulation (NFRC 200).
- ..... Other sections cover air leakage rate, energy rating (ER) of residential fenestration systems, reporting of results, markings, and condensation resistance.

**Table 1**  
**Reference fenestration system sizes for energy performance evaluation**  
 (See Clauses 4.2.1, 4.2.2, 4.2.7, 8.2, 9.2, and 9.3.)

Fenestration system type*	Outside dimensions of frame
	Width (mm ±100 mm) × height (mm ±100 mm)
Vertically sliding window	1200 × 1500
Horizontally sliding window	1500 × 1200
Dual-action window	1200 × 1500
Casement window	600 × 1500
Fixed window	1200 × 1500
Projected (awning/hopper) window	1500 × 600
Sliding door	2000 × 2000
Unit skylight/roof window†	1200 × 1200
Hinged doors	
Side-hinged door	1000 (or 2000‡) × 2000
Dual-action side-hinged door	1000 (or 2000‡) × 2000
Architectural terrace door	1000 (or 2000‡) × 2000
Sidelite	600 × 2000
Transom	2000 × 600
Curtain wall§ — vision panel	2000 × 2000
Curtain wall§ — spandrel panel**	2000 × 1000
Greenhouse/garden window	1500 × 1200
Tubular daylighting device	350 mm diameter

Fig. A1.1 Table 1 in A440.2-09.

## R2 Document Information

↔ National Fenestration Rating Council (NFRC). (2010). NFRC 100-2010 Procedure for Determining Fenestration Product U-factors. Greenbelt.

### Summary

The purpose of NFRC 100 is to specify a method for determining fenestration product thermal transmittance (U-factor or U-value).

### Key Points

- ↔ Currently the following products cannot be simulated: greenhouse/garden windows, tubular daylighting devices, hybrid TDDs, dynamic glazing products shipped with shading and diffusing systems external to the glazing, and domed skylights without frames or flashing. These products require physical testing to determine U-values (in accordance with NFRC 102).
- ↔ Discussion on product lines and grouping of products, allowable changes to an individual product, general simulation rules, etc.
- ↔ Standard sizes and configurations are given (see Fig. A2.1).
- ↔ References the NFRC simulation manual.
- ↔ Skylights and other sloped glazing products shall be simulated and rated at a slope of 20° from the horizontal. TDDs are tested with the tube in a vertical orientation. All other products are simulated in the vertical position.
- ↔ Simulations are to be completed using a software program compliant with ISO 15099, with some exceptions. Some of the exceptions include the area weighted method (Section 4.1.3 of ISO 15099) is the only method permitted (i.e. the alternate method of using edge-of-glass linear transmittance is not permitted), thermophysical properties are to be determined in accordance with NFRC 101, and environmental boundary conditions are to be in accordance with NFRC 100.
- ↔ Boundary conditions for use in the simulations are given. Boundary conditions include interior temperature of 21°C, exterior temperature of -18°C, wind speed of 5.5 m/s, and solar radiation of 0 W/m<sup>2</sup>, and surface film coefficients shown in Fig. A3.1 below.
  - ↔ Thermally broken members – system members with a minimum of 5.3 mm separation provided by a low conductance material (where thermal conductivity ≤ 0.5 W/m-K), or open air space between the interior and exterior surfaces.
  - ↔ Thermally improved members – system members with a separation ≥ 1.6 mm separation provided by a material (where thermal conductivity ≤ 0.5 W/m-K), or open air space between the interior and exterior surfaces.
- ↔ In general the procedure for determining the U-value of a fenestration product is as follows:
  - ↔ Determine centre-of-glazing U-value using centre-of-glazing simulation program
  - ↔ Determine edge-of-glazing U-value using two-dimensional heat transfer simulation program
  - ↔ Determine divider U-value (if applicable) using two-dimensional heat transfer simulation program
  - ↔ Determine frame U-value using two-dimensional heat transfer simulation program
  - ↔ Calculate areas of the above components, and perform an area-weighted U-value calculation
- ↔ Variations from the general requirements for certain product types.

**Table 4-3 – Product Types and Model Sizes**

Product Type	Opening (X) Non-operating (O)	Model Size (width by height)
		SI (IP)
Casement – Double <sup>1</sup>	XX, XO, OO	1200 mm x 1500 mm (47 in x 59 in)
Casement – Single	X <sup>7</sup>	600 mm x 1500 mm (24 in x 59 in)
Dual Action	X	1200mm x 1500 mm (47 in x 59 in)
Fixed (includes non-standard shapes)	O	1200 mm x 1500 mm (47 in x 59 in)
Garage(Vehicular Access)/Rolling Door	X	2134 mm x 2134 mm (84 in x 84 in)
Greenhouse/Garden <sup>2</sup>	X	1500 mm x 1200 mm (59 in x 47 in)
Hinged Escape	X	1500 mm x 1200 mm (59 in x 47 in)
Horizontal Slider	XO or XX	1500 mm x 1200 mm (59 in x 47 in)
Hybrid Tubular Daylighting Device	O	530 mm Dia. (21 in Dia.)
Jal/Jal Awning	X	1200 mm x 1500 mm (47 in x 59.in)
Pivoted	X	1200 mm x 1500 mm (47 in x 59 in)
Projecting (Awning, Dual)	XX	1500 mm x 1200 mm (59 in x 47 in)
Projecting (Awning – Single)	X	1500 mm x 600 mm (59 in x 24 in)
Door Sidelite <sup>6</sup>	X or O	600 mm x 2000 mm (24 in x 79 in)
Skylight/Roof Window	X <sup>3,7</sup>	1200 mm x 1200 mm (47 in x 47 in)
Sliding Patio Door with Frame	XO or XX <sup>9</sup>	2000 mm x 2000 mm (79 in x 79 in)
Curtain Wall/Window Wall/Sloped Glazing	OO <sup>4</sup>	2000 mm x 2000 mm (79 in x 79 in)
Spandrel Panel	OO	2000 mm x 1200 mm (79 in x 47 in)
Swinging Door with Frame	O, X, XO or XX <sup>5</sup>	960 mm x 2090 mm (37 3/4 in x 82 3/8 in); or 1920 mm x 2090 mm (75 1/2 in x 82 3/8 in)
Door Transom <sup>6,8</sup>	O	2000 mm x 600 mm (79 in x 24 in)
Tropical Awning	X	1500 mm x 1200 mm (59 in x 47 in)
Tubular Daylighting Device	O	350 mm Dia. (14 in Dia.)
Vertical Slider	XO or XX	1200 mm by 1500 mm (47 in by 59 in)

<sup>1</sup>Double Casements and Dual Awning are to be rated only in the case where single units are not manufactured.

<sup>2</sup>If not manufactured, use O (fixed unit).

<sup>3</sup>Fits over, or in, a 1180 mm by 1180 mm (46.5 in by 46.5 in) opening.

<sup>4</sup>Two lites with one vertical mullion. A multi-story system shall be simulated as a curtain wall and a single-story system shall be simulated as a window wall. Curtain walls shall be simulated and tested with intermediate verticals as jambs and intermediate horizontals as head/sill frame members. Window walls shall be simulated and tested with intermediate verticals as jambs and standard head and sill members. For rating of curtain walls and window walls, area weight intermediate members based on centerline dimensions. Sloped glazing may also be rated based on the centerline dimensions if utilized like a curtain or window wall, except for solariums and sunrooms. Sloped glazing of solariums and sunrooms shall be simulated and tested with standard jamb, head, and sill members (see Section 5.6.4.2). Other sloped glazing not similarly used like a flat curtainwall or windowwall, as identified under the "Sloped Glazing" definition, shall also be rated as sloped glazing products based on centerline dimensions and they shall be simulated and tested with purlins as head and sill and rafters as jambs and intermediate verticals.

<sup>5</sup>The single door shall be used to represent all door assemblies (single, double, multiple) unless the manufacturer does not produce a single door, in that case the double door shall be used to represent double and multiple door assemblies.

<sup>6</sup>Sidelites greater than 700 mm wide (27 in) and transoms greater than 700 mm (27 in) high shall be rated as fixed windows. Slab sidelites greater than 700 mm wide (27 in) shall be rated as swinging doors. Operable sidelites are rated as the appropriate operator type.

<sup>7</sup>Non-operating versions (O) of this type may be included in the same product line as the operable version as long as the changes to render the product non-operable comply with Section 4.2. If there is no operable version of the product, it is classified as a fixed window.

<sup>8</sup>Operable transoms are rated as the appropriate operator type.

<sup>9</sup>Representative of all sliding patio doors and combinations of sliding patio doors and fixed unit(s).

Fig. A2.1 Table 4-3 in NFRC 100.

Table 4-2 – Boundary Conditions

Boundary Condition	Radiation Model	Convective Film Coefficient Boundary	
		Tilt = 90° W/m <sup>2</sup> K (Btu/h·ft <sup>2</sup> ·°F)	Tilt = 20° W/m <sup>2</sup> K (Btu/h·ft <sup>2</sup> ·°F)
NFRC 100-2001 Exterior	Blackbody	26.00 (4.578)	26.00 (4.578)
Interior Aluminum Frame (convection only)	Automatic Enclosure Model	3.29 (0.579)	4.65 (0.819)
Interior Thermally Broken Frame (convection only)	Automatic Enclosure Model	3.00 (0.528)	4.09 (0.720)
Interior Thermally Improved Frame (convection only)	Automatic Enclosure Model	3.12 (0.549)	4.32 (0.761)
Interior Wood/Vinyl Frame (convection only)	Automatic Enclosure Model	2.44 (0.429)	3.09 (0.544)
Interior Glazing System boundary condition	Automatic Enclosure Model	Depends on the WINDOW calculations for the imported glazing system	

Fig. A3.1 Table 4-2 in NFRC 100.

### R3 Document Information

- National Fenestration Rating Council (NFRC). (2010). NFRC 200-2010 Procedure for Determining Fenestration Product Solar Heat Gain Coefficient and Visible Transmittance at Normal Incidence. Greenbelt.

### Summary

The purpose of NFRC 200 is to specify a method to calculate the Solar Heat Gain Coefficient (SHGC) and Visible Transmittance (VT) of fenestration products at normal incidence.

### Key Points

- Standard fenestration product sizes and configurations are the same as in NFRC 100.
- Centre-of-glazing SHGC is determined using the following conditions:
  - Interior temperature of 24°C
  - Exterior temperature of 32°C
  - Wind speed of 2.75 m/s
  - Solar radiation of 783 W/m<sup>2</sup>
- In general the procedure for determining SHGC is as follows:
  - Determine the centre-of-glazing SHGC<sub>c</sub> using an approved simulation program
  - Edge-of-glazing SHGC is equal to the centre-of-glazing SHGC
  - Obtain the frame representative SHGC<sub>0</sub> and SHGC<sub>1</sub>. SHGC<sub>0</sub> is the total fenestration product SHGC for the centre of glazing SHGC of 0, and SHGC<sub>1</sub> is the total fenestration product SHGC for the centre-of-glazing SHGC of 1.0.
  - Total fenestration product SHGC is calculated using  $SHGC = SHGC_0 + SHGC_c(SHGC_1 - SHGC_0)$
- Variations from the general requirements for certain product types.

#### **R4 Document Information**

..... Lawrence Berkeley National Laboratory. (2010). *THERM6 and WINDOW6*. Berkeley.

#### **Summary**

THERM version 6.3 and WINDOW version 6.3 are simulation programs approved by the NFRC for determining U-value and SHGC in accordance with NFRC 100 and NFRC 200, respectively.

#### **Key Points**

..... The algorithms in WINDOW6 and THERM6 follow the procedures presented in ISO 15099.

..... These simulation programs use the second or alternative method identified in ISO 15099 (i.e. the area weighting method).

## R5 Document Information

↻ Lawrence Berkeley National Laboratory. (2003). *THERM 5 / WINDOW 5 NFRC Simulation Manual*. Berkeley.

### Summary

This manual specifies how to use the THERM and WINDOW programs to model products for NFRC certification.

### Key Points

- ↻ The manual gives an overview of fenestration products and technology, plus fenestration heat transfer basics.
- ↻ A summary of algorithms used in WINDOW and THERM is given. The manual references ISO 15099, NFRC 100 and NFRC 200 for further details.
- ↻ Chapter on modeling centre-of-glazing provides an overview of WINDOW, including glass library, gas fills, environmental conditions, etc.
- ↻ Chapter on modeling frame and edge heat transfer provides an overview of THERM including frame cavities, importing glazing, boundary conditions, required simulation settings, etc.
- ↻ Provides guidance on certain special cases, such as storm windows, skylights, doors, non-continuous thermal bridge elements, etc.
- ↻ Appendix A, "The Application of ISO 15099 to NFRC 100 and 200", identifies specific differences between the two standards, including areas where ISO gives two options and NFRC does not. Some important differences highlighted in this appendix include,
  - ↻ For calculating the overall U-value, ISO 15099 offers a choice between the linear thermal transmittance and the area weighted method. In NFRC 100 only the area weighted method may be used.
  - ↻ Material conductivities and emissivities are to be determined in accordance with the NFRC Simulation Manual. ISO 15099 states these values should be taken from national standards whenever possible, or alternately ISO 10077-2, or determined in accordance with ISO 8302 (guarded hot plate) or ISO 8301 (heat flow meter).
  - ↻ NFRC 100 & 200 and ISO 15099 have different boundary conditions for both U-value and SHGC.





**Table A.1 — Surface thermal resistances**

<b>Window position</b>	<b>Internal</b> $R_{si}$ $m^2 \cdot K/W$	<b>External</b> $R_{se}$ $m^2 \cdot K/W$
Vertical, or inclination, $\alpha$ , of the glazing to the horizontal such that $90^\circ \geq \alpha \geq 60^\circ$ (heat flow direction $\pm 30^\circ$ from the horizontal plane)	0,13	0,04
Horizontal, or inclination $\alpha$ of the glazing to the horizontal such that $60^\circ > \alpha \geq 0^\circ$ (heat flow direction more than $30^\circ$ from the horizontal plane)	0,10	0,04

Fig. A5.1 Table A.1 in ISO 10077-1:2006.

**R7 Document Information**

International Organization for Standardization (ISO). (2009). ISO 10077-2:2006 Thermal performance of windows, doors and shutters – Calculation of thermal transmittance – Part 2: Numerical method for frames. Geneva.

**Summary**

Part two of ISO 10077 details calculation of the thermal characteristics of frame profiles for input into the Part 1 calculations.

**Key Points**

- The calculation method uses two dimensional numerical methods.
- The thermal transmittance of a frame section is determined with the glazing replaced by an insulating panel with thermal conductivity  $k = 0.035 \text{ W/m-K}$ .
- The linear thermal transmittance of the interaction of frame and glazing (edge effects) is determined both with the glazing in place and with the glazing replaced by an insulated panel.
- External and internal surface resistances for profiles are given (see Fig. A6.1). These surface resistances are to be used irrespective of the intended orientation of the window.
- Temperature conditions are to be  $20^\circ\text{C}$  interior and  $0^\circ\text{C}$  exterior.
- Regarding sloped glazing, although Part 2 applies to vertical frame profiles, it is an acceptable approximation for horizontal frame profiles (e.g. sill and head sections) and for products used in sloped positions (e.g. roof windows). In other words, the same methods in this standard apply regardless of the intended orientation of the window.
- Gives calculation for equivalent thermal conductivity of unventilated and ventilated air cavities in frames.
- Annex D gives examples to be used to validate the calculation program.

**Table B.1 — Surface resistances for profiles (horizontal heat flow)**

Position	External, $R_{se}$ $\text{m}^2\cdot\text{K}/\text{W}$	Internal, $R_{si}$ $\text{m}^2\cdot\text{K}/\text{W}$
Normal (plane surface)	0,04	0,13
Reduced radiation/convection (in edges or junctions between two surfaces, see Figure B1)	0,04	0,20
NOTE These values correspond to the surface resistance values given in ISO 6946, which also gives further information about the influence of convection and radiation on surface resistances.		

Fig. A6.1 Table B.1 in ISO 10077-2:2006.

## R8 Document Information

International Organization for Standardization (ISO). (2003). *ISO 15099:2003 Thermal performance of windows, doors and shading devices – Detailed calculations*. Geneva.

### Summary

This standard describes a procedure for calculating total fenestration product thermal transmittance, total solar energy transmittance, and visible light transmittance.

### Key Points

- Intended for use in computer programs.
- The scope includes fenestration products tilted at any angle.
- There are two options for calculating the total thermal transmittance of a fenestration product, differing in how the edge of glass effects are computed:
  - In the first option, the centre-of-glazing U-value ( $U_{gv}$ ), the frame U-value ( $U_f$ ), and the linear transmittance that accounts for the edge of glass effects ( $\Psi$ ) are used in the equation below (see Fig. A7.1). Calculations are performed without incident solar radiation. Additional details on the calculation of  $\Psi$  are given.
  - In the second option, the linear thermal transmittance for the edge of glass effects ( $\Psi$ ) is not used. Rather, the glass area is divided into centre-of-glass and edge-of-glass. An additional thermal transmittance is calculated for the edge of glass,  $U_{eg}$ , and the three resulting U-values (centre, edge and frame) are area-weighted (see Fig. A8.1).
  - Note these two methods have different definitions of frame thermal transmittance. In the second method (i.e. the area weighted method) the frame U-value includes some of the heat transfer caused by the edge seal, whereas in the first method (i.e. the linear transmittance method) it does not.

$$U_t = \frac{\sum A_{gv} U_{gv} + \sum A_f U_f + \sum l_{\Psi} \Psi}{A_t} \quad (1)$$

Fig. A7.1 Equation 1 in ISO 15099:2003.

$$U_t = \frac{\sum U_{cg} A_c + \sum U_{fr} A_f + \sum U_{eg} A_e + \sum U_{div} A_{div} + \sum U_{de} A_{de}}{A_t} \quad (10)$$

Fig. A8.1 Equation 10 in ISO 15099:2003.

- Describes calculation of vision area heat transfer and glazing system optics.
- Describes frame area thermal transmittance and edge linear thermal transmittance, also references ISO 10077-2.
- Gives a calculation for the total solar energy transmittance of a product,  $\tau_s$ , which is area weighted from the glass and frame solar energy transmittance values (i.e. a total product value).
- Standard boundary conditions for winter and summer are given with the following guidance: *“Unless a specific set of boundary conditions is of interest (e.g. to match test conditions, actual conditions, or to satisfy a national standard), the following standard boundary conditions shall be used.”*
  - Winter:
    - Interior temperature = 20°C
    - Exterior temperature = 0°C
    - $H_{cv, int} = 3.6 \text{ W/m}^2\text{-K}$
    - $H_{cv, ex} = 20 \text{ W/m}^2\text{-K}$
    - $I_s = 300 \text{ W/m}^2$

→ Summer

- Interior temperature = 25°C
- Exterior temperature = 30°C
- $H_{cv, int} = 2.5 \text{ W/m}^2\text{-K}$
- $H_{cv, ex} = 8 \text{ W/m}^2\text{-K}$
- $I_s = 500 \text{ W/m}^2$

## R9 Document Information

..... British Standards Institute (BSI). (2011). *BSI EN 673:2011 Glass in building – Determination of thermal transmittance (U value) – Calculation method*. London.

### Summary

The standard specifies a calculation method to determine the centre-of-glass thermal transmittance of glazing. It does not cover edge effects or energy transfer due to solar radiation. EN 673 is referenced by ISO 10077-1 (which details calculation of the overall fenestration product U-value). Note that the version reviewed here is the national British edition of the European Norm (EN).

### Key Points

- ..... Draft was originally based on ISO 10292.
- ..... Regarding sloped glazing, the standard states, *“For the purpose of comparison, a vertical position of the glazing is specified.”*
- ..... Equations for calculating U-value, including radiation conductance  $h_r$  and gas conductance  $h_g$ , are given.
- ..... Covers basic material properties including emissivity and gas properties.
- ..... The external heat transfer coefficient,  $h_e$ , is standardized to be  $25 \text{ W/m}^2\text{-K}$  for the purpose of comparing glazing U-values. For non-vertical surfaces the standard references ISO 6946.
- ..... The internal heat transfer coefficient,  $h_i$ , is standardized to be  $7.7 \text{ W/m}^2\text{-K}$  for the purpose of comparing glazing U-values. For non-vertical surfaces the standard references ISO 6946.

## R10 Document Information

..... International Organization for Standardization (ISO). (1994). *ISO 10292 Glass in building – Calculation of steady-state U values (thermal transmittance) of multiple glazing*. Geneva.

### Summary

This standard gives a procedure for calculating the thermal transmittance (U-value) for the centre-of-glass area. Edge-of-glass effects and thermal transmittance of the frame are not covered in this standard.

### Key Points

- ..... This standard is an older version of EN 673.
- ..... Covers basic formulae for calculating U-value, basic material properties, etc.
- ..... The external heat transfer coefficient,  $h_e$ , is standardized to be  $23 \text{ W/m}^2\text{-K}$  for the purpose of comparing glazing U-values.
- ..... The internal heat transfer coefficient,  $h_i$ , is standardized to be  $8.0 \text{ W/m}^2\text{-K}$  for the purpose of comparing glazing U-values.

**R11 Document Information**

..... International Organization for Standardization (ISO). (2007). *ISO 10211 Thermal bridges in building construction – Heat flows and surface temperatures – Detailed calculations*. Geneva.

**Summary**

This standard sets out specifications for a two-dimensional and three-dimensional geometrical model of a thermal bridge for the numerical calculation of heat flows and surface temperatures.

**Key Points**

- ..... Thermal bridges have two consequences compared with those of an unbridged structure: a change in heat flow rate, and a change in internal surface temperature.
- ..... Calculation of heat flows is for use in assessing the overall heat loss from a building or part of it, and calculation of surface temperatures can be used to assess the risk of surface condensation.
- ..... A geometrical model is divided into a number of adjacent material cells, each with a homogeneous thermal conductivity. Instructions for determining the thermal conductivities and boundary conditions are given. Calculation rules and methods of determining the temperature distribution are specified.
- ..... Results can be used to determine linear thermal transmittances, point thermal transmittances, and internal surfaces temperatures.
- ..... The standard gives numerous rules for modeling. For example,
  - ..... Dimensions may be measured using internal or external lengths as long as the same system is used consistently for all parts of a building.
  - ..... Partitioning is to be performed by choosing suitable cut-off planes, to avoid differences in the results of the calculation between partitioned building and the whole building.
  - ..... Conditions that are permitted for simplifying the geometrical model are described.
- ..... Other standards are referenced for thermal conductivities of materials, surface resistances, and thermal resistances of air layers and cavities.
- ..... Details calculation of linear and point thermal transmittances from two- and three-dimensional calculations.
- ..... Annex A gives test reference cases for the validation of the calculation methods.



## R12 Document Information

International Organization for Standardization (ISO). (2011). ISO 18292 Energy performance of fenestration systems for residential buildings - Calculation procedure. Geneva.

### Summary

This international standard specifies a procedure for determining energy ratings for window and door products based on thermal transmittance, solar gain and air infiltration. Additional discussion on this standard and differences compared to the Canadian ER can be found in the research report *Review of Window Energy Rating Procedure in Canada* (RDH, 2013).

### Key Points

- A separate energy performance value is calculated for heating and cooling conditions.
- The value is based on calculated annual energy per area caused by the fenestration product, in kWh/m<sup>2</sup>. The value is independent of the HVAC system.
- A national organization should determine calculation parameters including the reference building and climate dependent variables.
- The calculation uses a “gain utilization factor for heating” to prevent over-compensating for solar heat gain. This is determined based on the heat balance ratio for heating, i.e. total heat gains divided by total heat transfer. This method is different from the degree day method. In the degree day method, energy needs for heating do not take into account internal and solar gains, and this is compensated for by using a lower base temperature.

### R13 Document Information

→ British Standards Institute (BSI). (2011). *BSI EN 410:2011 Glass in building – Determination of luminous and solar characteristics of glazing*. London.

### Summary

This standard specifies methods for determining the luminous and solar characteristics of glazing in buildings for lighting, heating, and cooling calculations, and for comparing glazings.

### Key Points

→ Definitions:

→ “Total Solar Energy Transmittance (solar factor)” (g): fraction of the incident solar radiation that is totally transmitted by the glass.

→ “Shading Coefficient” (SC): ratio of the solar factor of the glass to the solar factor of a reference glass (clear float).

→ Solar factor g is calculated as the sum of the solar direct transmittance and the secondary heat transfer factor (heat transfer by convection and longwave IR radiation that is part of the incident solar radiation which has been absorbed by the glazing)

→ Shading coefficient, SC, is defined as  $SC = g / 0.87$ . The value of 0.87 corresponds to the total energy transmittance of a clear float glass with nominal thickness of 3mm to 4mm.

→ Uses CIE Standard Illuminant D65 spectral distribution. Note that NFRC 300-2010 also references the CIE D65 standard illuminant.

→ References EN 673 for calculating thermal conductance of multiple glazings.

→ From Window Optics website: EN 410 is virtually identical to ISO 9050.

→ Note that ISO 9050 is referenced by ISO 15099, which is in turn referenced by NFRC 200. EN 410 is referenced by Passive House.

## R14 Document Information

- Her Majesty's Government. (2010). L1A Conservation of fuel and power in new dwellings. United Kingdom.
- Her Majesty's. (2010). L2A Conservation of fuel and power in new buildings other than dwellings. United Kingdom.

## Summary

This building code references the standard BR 443 for the determination of fenestration product U-values.

## Key Points

- The maximum U-value for windows, roof windows, roof lights, curtain walling, and pedestrian doors is 2.2 W/m<sup>2</sup>-K in buildings other than dwellings, and 2.0 W/m<sup>2</sup>-K in dwellings.
- U-values are to be calculated in accordance with BR 443, and based on the whole product (i.e. glazing and frame).
- The U-value should be calculated for the following standard size:
  - The smaller of the two standard windows defined in BS EN 14351-1, or
  - The standard window configuration set out in BR 443, or
  - The specific size and configuration of the actual window
- Note BS EN 14351-1 is called "Windows and doors – Product standard, performance characteristics – Part 1: Windows and external pedestrian doorsets without resistance to fire and/or smoke leakage characteristics". This standard identifies performance characteristics that are applicable to windows.

## R15 Document Information

..... BRE. (2006). *BR 443 Conventions for U-value calculations*. Watford.

### Summary

This document specifies calculation methods for determining U-values for various building enclosure components by referencing other standards. For windows, ISO 10077 is referenced.

### Key Points

- ..... U-values for fenestration products obtained either by measurement (ISO 12567) or by numerical calculation (ISO 10077).
- ..... Standard size for windows in dwellings is 1.48 m high by 1.23 m wide, with a central vertical divider, one opening lite and one fixed lite. Details on standard window sizes are given in Glass and Glazing Federation (GGF) Data Sheet 2.2.
- ..... Regarding sloped glazing, the standard states that for the purpose of comparing products, U-values for windows or roof lights are calculated in the vertical plane. However, for the purpose of calculating heat losses from buildings, U-values for the product as installed in the building should be used. This can be done by calculating the U-value at the actual installed angle, or by using a conversion factor (see Fig. A9.1).

Inclination of roof	U-value adjustment (W/m <sup>2</sup> K)	
	Twin skin or double glazed	Triple skin or triple glazed
70° or more (treated as vertical)	0.0	0.0
<70° and > 60°	+ 0.2	+ 0.1
≤ 60° and > 40°	+ 0.3	+ 0.2
≤ 40° and > 20°	+ 0.4	+ 0.2
≤ 20° (treated as horizontal)	+ 0.5	+ 0.3

Fig. A9.1 BRE 443 table showing conversion factors for U-values of sloped fenestration products.

## R16 Document Information

..... Passivhaus Institut. (2007). Passive House Planning Package (PHPP) Version 1.0. Darmstadt.

### Summary

PHPP is a spreadsheet-based software tool that is used to design and assess Passive House buildings.

### Key Points

..... There are two sheets related to windows:

..... “WinType”: This sheet lists the characteristics of the glazings and frames present in the building. The user enters all glazing types and their corresponding centre-of-glass  $g$ -value (solar heat gain) and  $U_g$ -value (centre-of-glass U-value), according to certification. The user also enters all frame types and their corresponding  $U_f$ -value (frame U-value), frame dimensions,  $\Psi$ -spacer and  $\Psi$ -installation, according to certification. The  $\Psi$ -installation value accounts for thermal bridging of the window installation within the wall; some typical  $\Psi$ -installation values are given.

..... “Windows”: The user enters the quantity of each type of window, at each elevation. Required inputs include deviation from North, angle of inclination from the horizontal, width, and height. The particular glazing and frame systems are selected from the “WinType” worksheet, including  $g$ -value, U-value (glazing and frame), and the respective  $\Psi$  values for edge of glass spacer and installation perimeter. The overall U-value of the window,  $U_w$ , is calculated. The total overall transmission losses and solar heat gains through the window are calculated, in kWh/year.

## R17 Document Information

Passivhaus Institut. (2012). *Certification Criteria for Certified Passive House Glazings and Transparent Components*. Darmstadt.

### Summary

This document details the criteria for certifying glazing and transparent components. It includes certification criteria for windows including the standards to use for calculating U-values, standard sizes, and boundary conditions. Minimum U-value requirements for certification are given by climate zone. Note this is different from Passive House certification for full buildings – fenestration components may be certified by the Passive House Institute, however it is not required to use certified components in Passive House buildings.

### Key Points

- Functional requirements include hygiene requirements (to minimize condensation) and comfort requirements (surface temperatures and draughts).
- Defines efficiency classes to label products (from C, “certifiable component”, to A+, “very advanced component”)
- U-values and  $\Psi$ -values are to be calculated in accordance with ISO 10077, EN 673, and EN 13947 (thermal performance of curtain walling).
  - Centre-of-glazing U-values are calculated following EN 673.
  - Frame U-values and edge-of-glass  $\Psi$ -values follow ISO 10077-2, except the actual glass insertion depth should be used instead of the maximum depth in this standard.
  - Installation  $\Psi$ -values are determined through two-dimensional heat flow simulation. This component is not part of the ISO 10077 standard, but is calculated in accordance with ISO 10211.
- g-values (for the centre-of-glass) are calculated in accordance with EN 410, though there is no certification requirement for g-value.
- Requirements for certification include a maximum U-value for the whole window installed, a maximum U-value for the whole window (not installed), and a centre-of-glass U-value (see Fig. A10.1 and Fig. A11.1 below).
- Reference size for window U-value calculations is 1.23 m wide by 1.48 m high.
- U-values and  $\Psi$ -values for mullions may be reported for information.
- Roof windows are modeled at a 45° inclination.
- Boundary conditions for the calculation of U-values and  $\Psi$ -values are given (copied below in Fig. A12.1 and Fig. A13.1).

Table 2: Boundary conditions, acceptable certification criteria and efficiency classes for glazing

Region No.	Name	Boundary condition for hygiene criterion		Hygiene criterion		Ambient temperature for comfort criterion [°C]	Maximum heat transmission coefficient				Solar factor	Glazing efficiency classes For each class, $U_{eq}$ must be less than				
		$\theta_a$	rHi	$\theta_{S,min}$	$f_{Ra}$		Orientierung	[°]	$U_{W,installed}$	$U_w$		$U_g$	A	B	C	
1	Arctic	-34	0.40	9	0.80	-50	vertical	90	0.45	0.40	0.35	0.70	-0.10	-0.05	0.00	
							inclined	45	0.50	0.50	0.50					
							horizontal	0	0.60	0.60	0.60					
2	Cold	-16	0.45	11	0.75	-28	vertical	90	0.65	0.60	0.55	1.00	-0.15	-0.07	0.00	
							inclined	45	0.70	0.70	0.70					
							horizontal	0	0.80	0.80	0.80					
3	Cool-temperate	-5	0.50	13	0.70	-16	vertical	90	0.85	0.80	0.75	1.60	-0.35	-0.20	0.00	
							inclined	45	1.00	1.00	1.00					
							horizontal	0	1.10	1.10	1.10					
4	Warm-temperate	5	0.55	14	0.60	-3	vertical	90	1.30	1.25	1.20	3.20	-1.20	-0.90	-0.60	
							inclined	45	1.50	1.50	1.50					
							horizontal	0	1.70	1.70	1.70					
5	Warm	10	0.70	16	0.55	11	vertical	90	2.90	2.85	2.80	6.40	-3.00	-2.50	-2.00	
							inclined	45	3.30	3.30	3.30					
							horizontal	0	3.80	3.80	3.80					
6	Hot	not relevant		not defined		not relevant										
7	Extremely hot, often humid	not relevant		not defined		not relevant										

Fig. A10.1 Passive House certification criteria for fenestration.

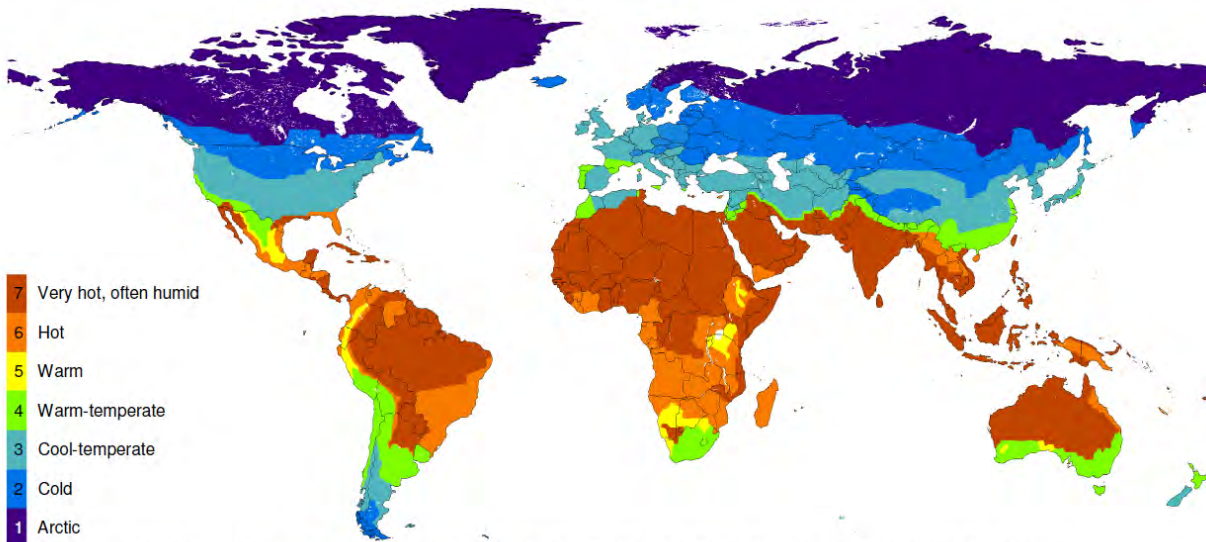

Figure 4: Classification of regions with equivalent requirements for Certified Passive House Glazings and Transparent Components

Fig. A11.1 Passive House certification regions.

### 6.3 Determination of glazing U-values

Glazing U-values  $U_g$  for certification are ascertained according to EN 673. A different outdoor temperature is taken for each region (see region classification above), as the glazing U-value is dependent on temperature difference whereas 20 °C is always used as the indoor temperature. In the "very hot, often humid", "hot", and "warm" regions, 20 °C is set as the outdoor temperature. In the heating-dominated regions, the outdoor temperature used is based on the average temperature during the Passive House heating period: for the "warm-temperate" region, 15 °C; for "cool-temperate", 5 °C; for "cold", -3 °C; for "arctic", -7 °C. In the cool-temperate region, values based on EN 673 are also acceptable.

Fig. A12.1 Passive House boundary conditions for the calculation of glazing U-values.

#### Boundary conditions for calculation of U and $\psi$ -values

- Exterior temperature: -10 °C
- Interior temperature: 20 °C

Heat transfer resistance $R_s$ [W/(m <sup>2</sup> K)]	Heat flow direction, inclination of building relative to horizontal		
	Upward, 0° ... 60°	Horizontal, 60° ... 120°	Downward, 0° ... 60°
Inside (EN 6946)	0.10	0.13	0.17
Inside - sloped glazing	$R_{Si} = -0.03 \cdot \cos \beta + 0.13$ ( $\beta$ = angle of inclination to horizontal)		
Increased on inside (at glass edge area)	0.20		
Outside (EN 6946)	0.04		
Outside (ventilated)	0.13		
Outside (against ground)	0.00		

Fig. A13.1 Passive House boundary conditions for the calculation of window frame U-values and  $\Psi$ -values.





<b>tab</b>	<b>Air temp</b>	<b>Convection Model:</b>	<b>Combined coef.</b>
<b>U-factor: Inside</b>	20 C	Fixed combined coefficient	$h_i = 1/0.13 \text{ m}^2\text{K/W} = 7.7 \text{ W/m}^2\text{K}$
<b>U-factor: Outside</b>	-10 C	Fixed combined coefficient	$h_a = 1/0.04 \text{ m}^2\text{K/W} = 25 \text{ W/m}^2\text{K}$
<b>SHGC: Inside</b>	25 C	Fixed combined coefficient	$h_i = 1/0.13 \text{ m}^2\text{K/W} = 7.7 \text{ W/m}^2\text{K}$
<b>SHGC: Outside</b>	30 C, Direct Solar Radiation 500 W/m <sup>2</sup>	Fixed combined coefficient	$h_a = 1/0.04 \text{ m}^2\text{K/W} = 25 \text{ W/m}^2\text{K}$

Table 1. PHI-adjusted environmental conditions for center-of-glass calculation.

Fig. A14.1 Table 1 showing Passive House boundary conditions for window simulations.

## R19 Document Information

⇨ ift Rosenheim. (2012). *Directive WA-15/2 Suitability of windows, exterior doors and curtain walling for Passive Houses*. Rosenheim.

### Summary

This standard establishes the process of assessing the Passive House construction suitability for building components of windows, exterior doors and curtain walls. It specifies the allowable heat loss through building connections of windows and exterior doors for Passive House assemblies. This standard offers an alternative Passive House evaluation of windows to the Passive House Institute program.

### Key Points

- ⇨ Windows and sliding doors must satisfy the following requirements:
  - ⇨ Maximum heat transfer coefficient of a single leaf window is  $U_w \leq 0.80 \text{ W/m}^2\text{-K}$ . Appropriate frame profiles and spacer systems must be used to meet this requirement using glazing with  $U_g = 0.7 \text{ W/m}^2\text{-K}$ .
  - ⇨ With glazing having  $U_g = 0.7 \text{ W/m}^2\text{-K}$ , the frame section must maintain a temperature factor of  $f_{0.13} \geq 0.88$ .
  - ⇨ The thermal transmittance of a window including the loss of heat at the connection to the structure must meet a requirement of  $U_{W,installed} \leq 0.85 \text{ W/m}^2\text{-K}$ .
  - ⇨ Where a panel or glass edge area is attached to the building structure, the panel or glass edge area must maintain a temperature factor of  $f_{Rsi} > 0.73$ .
- ⇨ Also gives requirements for exterior doors, glazing with muntin bars between window panes.
- ⇨ Passive House suitability determined using standard sizes. For a window, standard size is 1230 mm x 1480 mm.
- ⇨ References EN and ISO standards for the calculation of component values:
  - ⇨  $U_g$  values according to EN 673 and EN 674
  - ⇨  $U_f$  values according to ISO 10077-2 or EN 12412-2
  - ⇨  $\Psi_g$  values according to ISO 10077-2
  - ⇨  $W_w$  values according to ISO 10077-1, ISO 12567-1, or ISO 12567-2
- ⇨ Temperature factors
  - ⇨ Temperature factor  $f_{Rsi}$  is calculated as follows:  $f_{Rsi} = 1 - R_{si} \times U_f$
  - ⇨ Temperature factor  $f_{0.13} \geq 0.88$  is determined by using  $R_{si} = 0.13 \text{ m}^2\text{-K/W}$  ( $U_f$  determined following ISO 10077-2)
- ⇨ Additional requirements for air and water tightness, wind load, impact resistance